

EXPORT CATALOGUE

EFFECTIVE FROM MARCH 2025

LIFTING EQUIPMENT

AND ORIGINAL ACCESSORIES



SICE
AUTOMOTIVE EQUIPMENT

REL. MARCH 2026

COLOR TABLE

- 1) The standard company color of our lifting equipment is red RAL 3002 (->/16 or/15).
- 2) Any request for special painting according to the official RAL table has a specific fee (the surcharge is listed in the price list based on the selected range of lifters).

WARNING

THE FREE-OF-CHARGE CUSTOMIZATION KIT IS COMPULSORY AND MUST BE ALWAYS ORDERED TOGETHER WITH THE PART-NO. OF THE SELECTED LIFT.

NEXION SPA reserves the right to change the specifications of its products at any time without prior notice. The company declines all responsibility in the event of claims deriving from the use of non-original accessories or spare parts with consequent forfeiture of the EC declaration of conformity.

SUMMARY

UNDER-WHEEL SCISSOR LIFTS

PSR 50 WITH LIFT TABLE SERIES
 PSR 50 WITHOUT LIFT TABLE SERIES
 COMPULSORY ACCESSORIES PSR 50
 OPTIONAL ACCESSORIES PSR 50
 PSR 43 SERIES
 COMPULSORY ACCESSORIES PSR 43
 ACCESSORIES PSR 43
 OPTIONAL ACCESSORIES PSR 43
 PSR 55C CT LT
 PSR 55C CT
 PSR 55C
 PSR 45C CT LT
 PSR 45C CT
 PSR 45C

INGROUND LIFTS

PISC 3500.2 EVO
 PIDC 35.2 EVO
 PIDC 55.2
 COMPULSORY ACCESSORIES
 OPTIONAL ACCESSORIES

UNDERBODY DOUBLE SCISSOR LIFTS - LOW PROFILE

PSC 3000/ 3500/ 4000
 OPTIONAL ACCESSORIES
 PSC 3000E/ 3500E
 OPTIONAL ACCESSORIES
 PSC 3200C EF
 PSC 3600C EF

UNDERBODY DOUBLE SCISSOR LIFTS - HIGH PROFILE

PSCA 35 T -IN-PIT VERSION
 PSCA 40 T -IN-PIT VERSION
 PSCA 35E - INCASSO
 PSCA 40E - INCASSO
 OPTIONAL ACCESSORIES - PSCA 35T - 35E - 40T - 40E - IN-PIT VERSION
 PSCA 36C T E
 PSCA 40C T E

UNDERBODY SINGLE SCISSOR LIFTS - LOW PROFILE

PSCE 300

5	PSCE 305	55
5	OPTIONAL ACCESSORIES	56
6	PSCE 350C B	59
8	ELECTRO-MECHANICAL TWO POST LIFTS	62
9	PDC 30	62
13	COMPULSORY ACCESSORIES - PDC 30	63
15	OPTIONAL ACCESSORIES - PDC 30	63
16	PDC 32N	64
17	PDC 32N CEL	65
20	PDC 40N CEL	66
21	PDC 40 ELX	67
22	PDC 50	68
23	COMPULSORY ACCESSORIES - PDC 32N - 40N - PDC 40 ELX - PDC 50	69
24		
25	ELECTRO-HYDRAULIC TWO POST LIFTS	72
	PDCH 32 SERIES	72
28	COMPULSORY ACCESSORIES - PDCH 32 SERIES	73
28	OPTIONAL ACCESSORIES - PDCH 32 SERIES	73
29	PDCH 35C B	74
30	PDCH 45C B	75
31	PDCH 40E SERIES	78
32	PDCH 40N SERIES	79
	PDCH 50 SERIES	80
35	COMPULSORY ACCESSORIES PDCH 40E-PDCH 40N-PDCH 50 SERIES	81
35	OPTIONAL ACCESSORIES PDCH 40E-PDCH 40N-PDCH 50 SERIES	82
36	PDCH 55 XV SERIES	84
40	COMPULSORY ACCESSORIES - PDCH 55 XV	85
42	OPTIONAL ACCESSORIES - PDCH 55XV	85
44	PDCH 40C	86
45	PDCH 45C	89
	PDCH 55C	90
48		
48	ELECTRO-HYDRAULIC FOUR POST LIFTS	93
48	PQC 40 SERIES	93
49	PQC 50 SERIES	94
49	COMPULSORY ACCESSORIES PQC 40 - PQC 50 SERIES	95
50	OPTIONAL ACCESSORIES PQC 40 - PQC 50 SERIES	95
52		
53	PLATFORM LIFTS	97
	S 227	97
55	OPTIONAL ACCESSORIES S 227	98
55		

MOTORCYCLE LIFTS

PM 26	99
PM 23	99
OPTIONAL ACCESSORIES PM 26 - PM 23	100

AIR HYDRAULIC JACKS

K002	103
K118	103
K240	103
K240P	103
K330	103
K440	103

WIRELESS HYDRAULIC MOBILE COLUMNS

PMC65 H / PMC75 H / PMC86 H	104
OPTIONAL ACCESSORIES FOR WIRELESS HYDRAULIC MOBILE COLUMNS	105

LIFTS FOR TRUCKS AND INDUSTRIAL VEHICLES WITH MOBILE COLUMNS

MC 75	106
MC 55	107
OPTIONAL ACCESSORIES - MC 75 - MC 55	108
PSRC 280 SERIES	110

PSR 50 WITH LIFT TABLE SERIES

5000



Code	Electric Supply	Description	
0-42109500/15	400-230V/ 3Ph/ 50-60Hz	PSR 50 LT , flat runways	
0-42109700/15	400-230V/ 3Ph/ 50-60Hz	PSR 50 LT PT2 , flat runways, 2 mov. play detector.	
0-42109710/15	400V/ 3Ph/ 50Hz	PSR 50 LT PT2 FAST , flat runways, 2 mov. play detector, FAST version.	
0-42109750/15	400-230V/ 3Ph/ 50-60Hz	PSR 50 LT PT6 , flat runways, 6 mov. play detector.	
0-42109760/15	400V/ 3Ph/ 50Hz	PSR 50 LT PT6 FAST , flat runways, 6 mov. play detector, FAST version.	
0-42109770/15	400V/ 3Ph/ 50Hz	PSR 50 LT PT6 Wi FAST , flat runways, 6 mov. play detector, FAST version, Wireless for play detector	
0-42110200/15	400-230V/ 3Ph/ 50-60Hz	PSR 50 CT LT , for complete alignment.	
0-42109900/15	400-230V/ 3Ph/ 50-60Hz	PSR 50 CT LT PT2 , for complete alignment, 2 mov. play detector.	
0-42109910/15	400-230V/ 3Ph/ 50-60Hz	PSR 50 CT LT PT2 FAST , for complete alignment, 2 mov. play detector, FAST version.	
0-42110300/15	400-230V/ 3Ph/ 50-60Hz	PSR 50 CT LT PT6 for complete alignment, 6 mov. play detector.	
0-42110360/15	400V/ 3Ph/ 50Hz	PSR 50 CT LT PT6 FAST , for complete alignment, 6 mov. play detector, FAST version.	
0-42100370/15	400V/ 3Ph/ 50Hz	PSR 50 CT LT PT6 Wi FAST , for complete alignment, 6 mov. play detector, FAST version, Wireless for play detector.	

PSR 50 WITHOUT LIFT TABLE SERIES

5000





Code	Electric Supply	Description	
0-42109400/15	400-230V/ 3Ph/ 50-60Hz	PSR 50 flat runways.	
0-42109600/15	400-230V/ 3Ph/ 50-60Hz	PSR 50 PT2 flat runways, 2 mov. play detector.	
0-42109610/15	400V/ 3Ph/ 50Hz	PSR 50 PT2 FAST flat runways, 2 mov. play detector, FAST version.	
0-42109650/15	400-230V/ 3Ph/ 50-60Hz	PSR 50 PT6 flat runways, 6 mov. play detector.	
0-42109660/15	400V/ 3Ph/ 50Hz	PSR 50 PT6 FAST flat runways, 6 mov. play detector, FAST version.	
0-42109670/15	400V/ 3Ph/ 50Hz	PSR 50 PT6 Wi FAST flat runways, 6 mov. play detector, FAST version, Wireless for play detector.	
0-42109800/15	400-230V/ 3Ph/ 50-60Hz	PSR 50 CT for complete alignment.	
0-42111200/15	400-230V/ 3Ph/ 50-60Hz	PSR 50 CT PT2 for complete alignment, 2 mov. play detector.	
0-42111210/15	400V/ 3Ph/ 50Hz	PSR 50 CT PT2 FAST for complete alignment, 2 mov. play detector.	
0-42111250/15	400-230V/ 3Ph/ 50-60Hz	PSR 50 CT PT6 for complete alignment, 6 mov. play detector.	
0-42111260/15	400V/ 3Ph/ 50Hz	PSR 50 CT PT6 FAST for complete alignment, 6 mov. play detector, FAST version.	
0-42111270/15	400V/ 3Ph/ 50Hz	PSR 50 CT PT6 Wi FAST or complete alignment, 6 mov. play detector, FAST version, Wireless for play detector.	





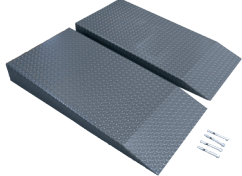
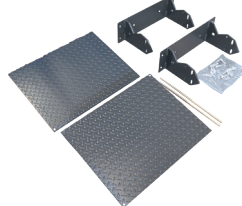

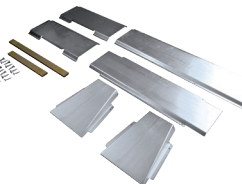
Installation Configuration PSR 50 with lift table							
		Flush Installation		On-Floor Installation			
		A	B	C	D	E	F
		<i>Flap and Front Stopper</i>	<i>DRIVE-THROUGH Ramps</i>	<i>Ramps on Floor</i>	<i>Hanging ramps</i>	<i>DRIVE-THROUGH Ramps on floor</i>	<i>DRIVE-THROUGH hanging ramps</i>
Accessory description		Quantity	Quantity	Quantity	Quantity	Quantity	Quantity
8-42300048	<i>Floor ramp kit L=1300 mm</i>			1		2	
8-42300054	<i>Flap wheel stop (2pcs)</i>	1	2	1		2	
8-42300055	<i>Front wheel block kit</i>	1		1	1		
8-42300056	<i>On-floor installation kit</i>			1	1	1	1
8-42300057	<i>In-pit installation kit</i>	1	1				
8-42100236/S34	<i>Two-part splitted drive-on ramps L1630 mm</i>				1		2

Installation Configuration PSR 50 without lift Table							
		Flush Installation		On-Floor Installation			
		A	B	C	D	E	F
		<i>Flap and Front Stopper</i>	<i>DRIVE-THROUGH Ramps</i>	<i>Ramps on Floor</i>	<i>Hanging ramps</i>	<i>DRIVE-THROUGH Ramps on floor</i>	<i>DRIVE-THROUGH hanging ramps</i>
Accessory description		Quantity	Quantity	Quantity	Quantity	Quantity	Quantity
8-42300048	<i>Floor ramp kit L=1300 mm</i>			1		2	
8-42300054	<i>Flap wheel stop (2pcs)</i>	1	2	1		2	
8-42300055	<i>Front wheel block kit</i>	1		1	1		
8-42300056	<i>On-floor installation kit</i>			1	1	1	1
8-42300057	<i>In-pit installation kit</i>	1	1				
8-42100236/S34	<i>Two-part splitted drive-on ramps L1630 mm</i>				1		2

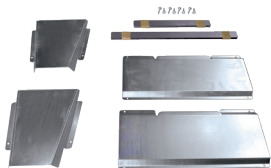

COMPULSORY ACCESSORIES PSR 50

Image	Description	Code		PSR 50 LT	PSR 50 LT PT2	PSR 50 LT PT2 FAST	PSR 50 LT PT6	PSR 50 LT PT6 FAST	PSR 50 LT PT6 WI FAST	PSR 50 CT LT	PSR 50 CT LT PT2	PSR 50 CT LT PT2 FAST	PSR 50 CT LT PT6	PSR 50 CT LT PT6 FAST	PSR 50 CT LT PT6 WI FAST	PSR 50	PSR 50 PT2	PSR 50 PT2 FAST	PSR 50 PT6	PSR 50 PT6 FAST	PSR 50 PT6 WI FAST	PSR 50 CT	PSR 50 CT PT2	PSR 50 CT PT2 FAST	PSR 50 CT PT6	PSR 50 CT PT6 FAST	PSR 50 CT PT6 WI FAST
	Floor ramp kit. L=1300 mm	8-42300048		○	○	○	○	○	○	○	○	○	○	○	○	○	○	○	○	○	○	○	○	○	○	○	○
	Flap wheel stop (2 cps).	8-42300054		○	○	○	○	○	○	○	○	○	○	○	○	○	○	○	○	○	○	○	○	○	○	○	○
	Front wheel block kit.	8-42300055		○	○	○	○	○	○	○	○	○	○	○	○	○	○	○	○	○	○	○	○	○	○	○	○
	On-floor installation kit (valid also for built-in when one unique pit is present).	8-42300056		○	○	○	○	○	○	○	○	○	○	○	○	○	○	○	○	○	○	○	○	○	○	○	○

OPTIONAL ACCESSORIES PSR 50

Image	Description	Code																										
			PSR 50 LT	PSR 50 LT PT2	PSR 50 LT PT2 FAST	PSR 50 LT PT6	PSR 50 LT PT6 FAST	PSR 50 LT PT6 Wi FAST	PSR 50 CT LT	PSR 50 CT LT PT2	PSR 50 CT LT PT2 FAST	PSR 50 CT LT PT6	PSR 50 CT LT PT6 FAST	PSR 50 CT LT PT6 Wi FAST	PSR 50	PSR 50 PT2	PSR 50 PT2 FAST	PSR 50 PT6	PSR 50 PT6 FAST	PSR 50 PT6 Wi FAST	PSR 50 CT	PSR 50 CT PT2	PSR 50 CT PT2 FAST	PSR 50 CT PT6	PSR 50 CT PT6 FAST	PSR 50 CT PT6 Wi FAST		
	In-pit <i>installation kit</i> .	8-42300057	0	0	0	0	0	0	0	0	0	0	0	0	0	0	0	0	0	0	0	0	0	0	0	0	0	0
	<i>Kit of spacers</i> to reduce the size of the turntable housing to 460 mm, only for CT LT versions.	8-42300058	-	-	-	-	-	-	0	0	0	0	0	0	-	-	-	-	-	-	-	-	-	-	-	-	-	-
	<i>Extra floor ramp kit</i> . L closed =1120 mm L open =1920 mm L intermediate =1520 mm	8-42300030	0	0	0	0	0	0	0	0	0	0	0	0	0	0	0	0	0	0	0	0	0	0	0	0	0	0
	<i>Lighting kit</i> (4 leds).	8-42300060	0	0	0	0	0	0	0	0	0	0	0	0	0	0	0	0	0	0	0	0	0	0	0	0	0	0
	Set of 4 pads, H=80 mm.	8-42300027	0	0	0	0	0	0	0	0	0	0	0	0	0	0	0	0	0	0	0	0	0	0	0	0	0	0
	Set of 4 pads, H=40 mm.	8-42300028	0	0	0	0	0	0	0	0	0	0	0	0	0	0	0	0	0	0	0	0	0	0	0	0	0	0

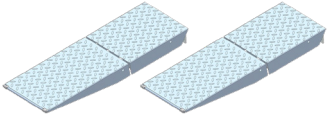
OPTIONAL ACCESSORIES PSR 50

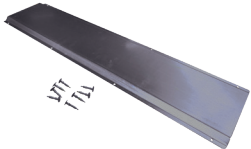
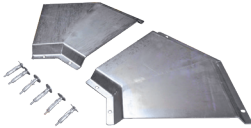
Image	Description	Code																										
			PSR 50 LT	PSR 50 LT PT2	PSR 50 LT PT2 FAST	PSR 50 LT PT6	PSR 50 LT PT6 FAST	PSR 50 LT PT6 WI FAST	PSR 50 CT LT	PSR 50 CT LT PT2	PSR 50 CT LT PT2 FAST	PSR 50 CT LT PT6	PSR 50 CT LT PT6 FAST	PSR 50 CT LT PT6 WI FAST	PSR 50	PSR 50 PT2	PSR 50 PT2 FAST	PSR 50 PT6	PSR 50 PT6 FAST	PSR 50 PT6 WI FAST	PSR 50 CT	PSR 50 CT PT2	PSR 50 CT PT2 FAST	PSR 50 CT PT6	PSR 50 CT PT6 FAST	PSR 50 CT PT6 WI FAST		
	Two-part splitted drive-on ramps L1630 mm	8-42100236/S34	○	○	○	○	○	○	○	○	○	○	○	○	○	○	○	○	○	○	○	○	○	○	○	○	○	○
	Pipe extensions kit , L= 4m	8-42300064	-	○	○	○	○	○	-	○	○	○	○	○	-	-	-	-	-	-	-	-	-	-	-	-	-	
	Pipe extensions kit , L= 4m	8-42300095	○	-	-	-	-	-	-	○	-	-	-	-	-	-	-	-	-	-	-	-	-	-	-	-	-	
	Pipe extensions kit , L= 4m	8-42300097	-	-	-	-	-	-	-	-	-	-	-	-	-	-	○	○	○	○	○	-	○	○	○	○	○	
	Pipe extensions kit , L= 4m	8-42300094	-	-	-	-	-	-	-	-	-	-	-	-	-	○	-	-	-	-	-	○	-	-	-	-	-	
	Pipe extensions kit , L= 2m	8-42300080	-	○	○	○	○	○	○	-	○	○	○	○	○	-	-	-	-	-	-	-	-	-	-	-	-	-
	Pipe extensions kit , L= 2m	8-42300100	○	-	-	-	-	-	-	○	-	-	-	-	-	-	-	-	-	-	-	-	-	-	-	-	-	
	Pipe extensions kit , L= 2m	8-42300102	-	-	-	-	-	-	-	-	-	-	-	-	-	-	○	○	○	○	○	-	○	○	○	○	○	
Pipe extensions kit , L= 2m	8-42300099	-	-	-	-	-	-	-	-	-	-	-	-	-	○	-	-	-	-	-	○	-	-	-	-	-		
	Protection kit for pipes, 1 mt.	8-42300081	○	○	○	○	○	○	○	○	○	○	○	○	○	○	○	○	○	○	○	○	○	○	○	○	○	
	Angle protections kit for pipes.	8-42300082	○	○	○	○	○	○	○	○	○	○	○	○	○	○	○	○	○	○	○	○	○	○	○	○	○	

OPTIONAL ACCESSORIES PSR 50

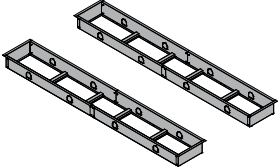
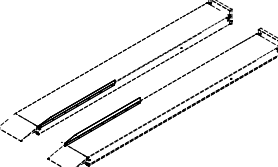
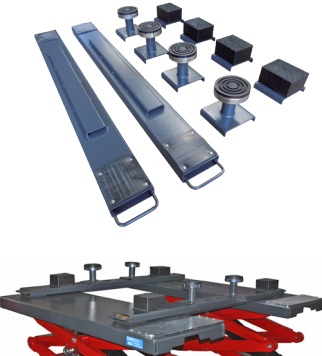
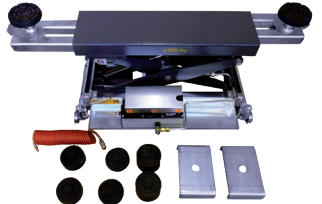
Image	Description	Code		PSR 50 LT	PSR 50 LT PT2	PSR 50 LT PT2 FAST	PSR 50 LT PT6	PSR 50 LT PT6 FAST	PSR 50 LT PT6 Wi FAST	PSR 50 CT LT	PSR 50 CT LT PT2	PSR 50 CT LT PT2 FAST	PSR 50 CT LT PT6	PSR 50 CT LT PT6 FAST	PSR 50 CT LT PT6 Wi FAST	PSR 50	PSR 50 PT2	PSR 50 PT2 FAST	PSR 50 PT6	PSR 50 PT6 FAST	PSR 50 PT6 Wi FAST	PSR 50 CT	PSR 50 CT PT2	PSR 50 CT PT2 FAST	PSR 50 CT PT6	PSR 50 CT PT6 FAST	PSR 50 CT PT6 Wi FAST
	<p>Frame se for in-pit installation (2pcs). Long.= 5910mm Larg.= 816mm H= 336mm</p>	8-42300083		○	○	○	○	○	○	○	○	○	○	○	○	○	○	○	○	○	○	○	○	○	○	○	○
	<p>Runways edges kit.</p>	8-42300084		○	○	○	○	○	○	○	○	○	○	○	○	○	○	○	○	○	○	○	○	○	○	○	○
	<p>Pair of beams for all-terrain vehicles.</p>	8-42300047		○	○	○	○	○	○	○	○	○	○	○	-	-	-	-	-	-	-	-	-	-	-	-	-
	<p>JB22 - Pneumo-hydraulic cross beam (2200 kg).</p>	8-42100015		○	○	○	○	○	○	○	○	○	○	○	○	○	○	○	○	○	○	○	○	○	○	○	○

OPTIONAL ACCESSORIES PSR 50

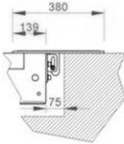
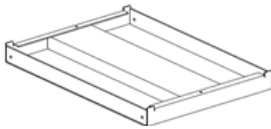
Image	Description	Code		PSR 50 LT	PSR 50 LT PT2	PSR 50 LT PT2 FAST	PSR 50 LT PT6	PSR 50 LT PT6 FAST	PSR 50 LT PT6 Wi FAST	PSR 50 CT LT	PSR 50 CT LT PT2	PSR 50 CT LT PT2 FAST	PSR 50 CT LT PT6	PSR 50 CT LT PT6 FAST	PSR 50 CT LT PT6 Wi FAST	PSR 50	PSR 50 PT2	PSR 50 PT2 FAST	PSR 50 PT6	PSR 50 PT6 FAST	PSR 50 PT6 Wi FAST	PSR 50 CT	PSR 50 CT PT2	PSR 50 CT PT2 FAST	PSR 50 CT PT6	PSR 50 CT PT6 FAST	PSR 50 CT PT6 Wi FAST
IMAGE NOT AVAILABLE	Customization kit for JB22.	8-42100123		O	O	O	O	O	O	O	O	O	O	O	O	O	O	O	O	O	O	O	O	O	O	O	O
IMAGE NOT AVAILABLE	Optional air connection kit with hose reel (Attention: must be ordered together with the lift, it's not included with the scissor Jack)	8-42100162		O	O	O	O	O	O	O	O	O	O	O	O	O	O	O	O	O	O	O	O	O	O	O	O
	Shortened flap , adding an extra length of only 75mm, instead of 300mm with standard flap. Is especially useful for recessed installation into existing recess	8-42120023		O	O	O	O	O	-	-	-	-	-	-	O	O	O	O	O	O	O	-	-	-	-	-	-
 <p>x2</p>	Set of 2 filling pieces, 450mm - powder coated. Needed when no turning tables are used	8-42120034		-	-	-	-	-	O	O	O	O	O	O	-	-	-	-	-	-	O	O	O	O	O	O	O

PSR 43 SERIES

4300





Code	Electric Supply	Description	
WITH LIFT TABLE			
0-42401000/15	400-230V/ 3Ph/ 50-60Hz	PSR 43 LT with Lift Table.	
0-42400400/15	400-230V/ 3Ph/ 50-60Hz	PSR 43 CT LT for complete alignment and Lift Table.	
0-42400450/15	400-230V/ 3Ph/ 50-60Hz	PSR 43 CT LT for complete alignment and Lift Table, runways length = 4200 mm.	
0-42401260/15	230-400V/3 Ph/50-60Hz	PSR 43 LT PT6 FAST , Lift Table, flat runways, 6 mov.play detector, FAST version	
0-42401360/15	230-400V/3 Ph/50-60Hz	PSR 43 CT LT PT6 FAST , for complete alignment, Lift Table, flat runways, 6 mov.play detector, FAST version	
WITHOUT LIFT TABLE			
0-42400100/15	400-230V/ 3Ph/ 50-60Hz	PSR 43 flat runways.	
0-42400200/15	400-230V/ 3Ph/ 50-60Hz	PSR 43 CT for complete alignment.	
0-42400300/15	400-230V/ 3Ph/ 50-60Hz	PSR 43 PT2 flat runways, 2 mov.play detector.	
0-42400500/15	400-230V/ 3Ph/ 50-60Hz	PSR 43 PT2 FAST flat runways, 2 mov.play detector, FAST version.	
0-42401160/15	230-400V/3 Ph/50-60Hz	PSR 43 PT6 FAST , with flat runways, 6 mov.play detector, FAST version	



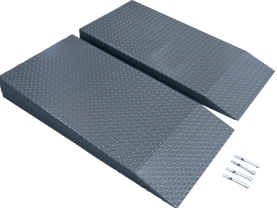
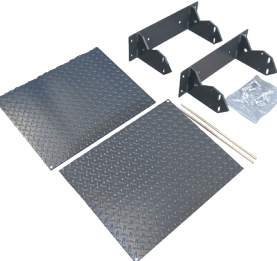

Installation Configuration PSR 43

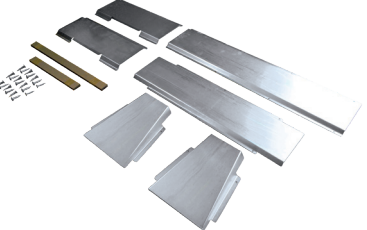
		Flush Installation		On-Floor Installation			
		A	B	C	D	E	F
		<i>Flap and Front Stopper</i>	<i>DRIVE-THROUGH Ramps</i>	<i>Ramps on Floor</i>	<i>Hanging ramps</i>	<i>DRIVE-THROUGH Ramps on floor</i>	<i>DRIVE-THROUGH hanging ramps</i>
<i>Accessory description</i>		<i>Quantity</i>	<i>Quantity</i>	<i>Quantity</i>	<i>Quantity</i>	<i>Quantity</i>	<i>Quantity</i>
8-42300048	<i>Floor ramp kit L=1300 mm</i>			1		2	
8-42300054	<i>Flap wheel stop (2pcs)</i>	1	2	1		2	
8-42300055	<i>Front wheel block kit</i>	1		1	1		
8-42300056	<i>On-floor installation kit</i>			1	1	1	1
8-42300057	<i>In-pit installation kit</i>	1	1				
8-42100236/S34	<i>Two-part splitted drive-on ramps L1630 mm</i>				1		2

COMPULSORY ACCESSORIES PSR 43

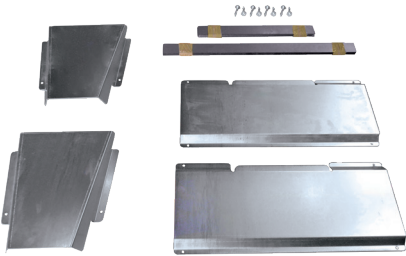
Image	Description	Code		PSR 43	PSR 43 PT2	PSR 43 PT2 FAST	PSR 43 CT	PSR 43 CT LT
	<p>Floor ramp kit. L=1300 mm</p>	8-42300048		○	○	○	○	○
	<p>Flap wheel stop (2 pcs).</p>	8-42300054		○	○	○	○	○
	<p>Front wheel block kit.</p>	8-42300055		○	○	○	○	○
	<p>On-floor installation kit (valid also for built-in when one unique pit is present).</p>	8-42300056		○	○	○	○	○



OPTIONAL ACCESSORIES PSR 43

Image	Description	Code		PSR 43	PSR 43 PT2	PSR 43 PT2 FAST	PSR 43 CT	PSR 43 CT LT
	<p>In-pit installation kit.</p>	8-42300057		○	○	○	○	○
	<p>Extra floor ramp kit. L closed = 1120 mm L open = 1920 mm L intermediate = 1520 mm</p>	8-42300030		○	○	○	○	○
	<p>Lighting kit (4 leds).</p>	8-42300060		○	○	○	○	○
	<p>Set of 4 pads, H=80 mm.</p>	8-42300027		○	○	○	○	○
	<p>Set of 4 pads, H=40 mm.</p>	8-42300028		○	○	○	○	○

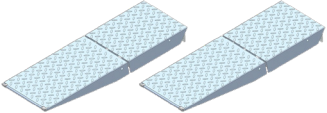
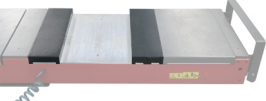
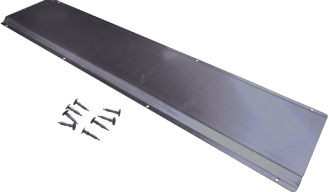
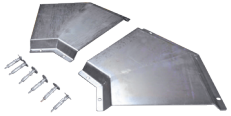
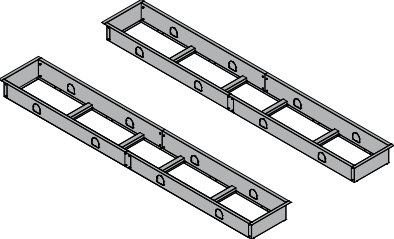
OPTIONAL ACCESSORIES PSR 43

Image	Description	Code		PSR 43	PSR 43 PT2	PSR 43 PT2 FAST	PSR 43 CT	PSR 43 CT LT
	<p>Two-part splitted drive-on ramps L1630 mm</p>	8-42100236/S34		○	○	○	○	○
	<p>Kit of spacers to reduce the size of the turntable housing to 460 mm, only for CT LT version.</p>	8-42120029		-	-	-	-	○
	<p>Protection kit for pipes L= 1mt.</p>	8-42300081		○	○	○	○	○
	<p>Angle protections kit for pipes.</p>	8-42300082		○	○	○	○	○
	<p>Frame se for in-pit installation (2pcs). Long. = 5210 mm Larg. = 815 mm h. = 320 mm</p>	8-42120016		○	○	○	○	○

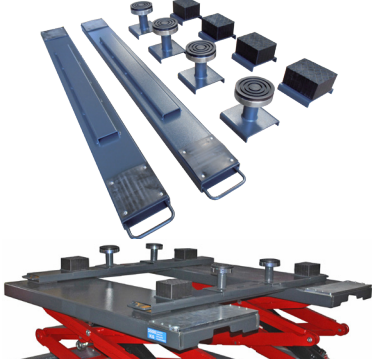
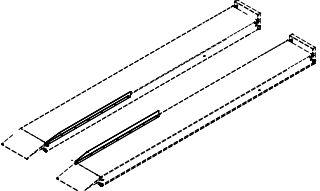
OPTIONAL ACCESSORIES PSR 43

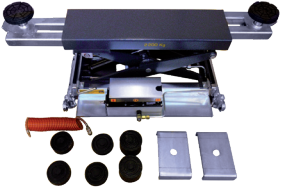
Image	Description	Code		PSR 43	PSR 43 PT2	PSR 43 PT2 FAST	PSR 43 CT	PSR 43 CT LT
	<p><i>Pair of beams</i> for all-terrain vehicles, L=1800 mm.</p>	8-42300047		-	-	-	-	O
	<p><i>Runways edges kit.</i></p>	8-42120017		O	O	O	O	O
	<p><i>Pipe extensions kit</i>, L= 4m</p>	8-42300095		-	-	-	-	O
	<p><i>Pipe extensions kit</i>, L= 4m</p>	8-42300097		-	O	O	-	-
	<p><i>Pipe extensions kit</i>, L= 4m</p>	8-42300094		O	-	-	O	-
	<p><i>Pipe extensions kit</i>, L= 2m</p>	8-42300100		-	-	-	-	O
	<p><i>Pipe extensions kit</i>, L= 2m</p>	8-42300102		-	O	O	-	-
	<p><i>JB22</i> Pneumo-hydraulic cross beam (2200 kg).</p>	8-42100015		O	O	O	O	O

OPTIONAL ACCESSORIES PSR 43

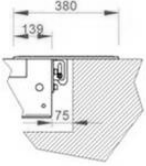
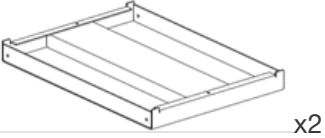
Image	Description	Code		PSR 43	PSR 43 PT2	PSR 43 PT2 FAST	PSR 43 CT	PSR 43 CT LT
IMAGE NOT AVAILABLE	Customization kit for JB22.	8-42100123		○	○	○	○	○
IMAGE NOT AVAILABLE	Optional air connection kit with hose reel (Attention: must be ordered together with the lift, it's not included with the scissor Jack)	8-42100162		○	○	○	○	○
	Shortened flap , adding an extra length of only 75mm, instead of 300mm with standard flap. Is especially useful for recessed installation into existing recess	8-42120023		○	○	○	○	○
	Set of 2 filling pieces, 450mm - powder coated. Needed when no turning tables are used	8-42120034		-	-	-	○	○

PSR 55C CT LT

WITH LIFT TABLE "LT"

Main features:

- Capacity: 5.500 kg
- Low profile platform scissor lift with lifting table for wheel alignment.
- Automatic runway levelling system with master/slave hydraulic circuit.
- Runway length: 4600 mm/ 5200 mm



5500



All models supplied with:

- 1 Set of 4 hard rubber blocks.

PN	Power supply	Description	
0-42116000/15	230-400V/3Ph/50-60Hz	PSR 55C CT LT , with LT lift table, runway length 4600 mm	
8-42400163		Customization kit - PSR 55C CT LT, compulsory	
0-42116010/15	230-400V/3Ph/50-60Hz	PSR 55C CT LT I , with LT lift table, runway length 4600 mm, in-pit installation	
8-42400223		Customization kit - PSR 55C CT LT I, compulsory	
0-42116500/15	230-400V/3Ph/50-60Hz	PSR 55C CT LT , with LT lift table, runway length 5200 mm	
8-42400219		Customization kit - PSR 55C CT LT, compulsory	
0-42116510/15	230-400V/3Ph/50-60Hz	PSR 55C CT LT I , with LT lift table, runway length 5200 mm, in-pit installation	
8-42400224		Customization kit - PSR 55C CT LT I, compulsory	

PSR 55C CT

Main features:

- Capacity: 5.500 kg
- Low profile platform scissor lift for wheel alignment.
- Automatic runway levelling system with master/slave hydraulic circuit.
- Runway length: 4600 mm/ 5200 mm



5500



All models supplied with:

- 1 Set of 4 hard rubber blocks.

PN	Power supply	Description	
0-42112100/15	230-400V/3Ph/50-60Hz	PSR 55C CT , runway length 4600 mm	
8-42400164		Customization kit - PSR 55C CT, compulsory	
0-42112110/15	230-400V/3Ph/50-60Hz	PSR 55C CT I , runway length 4600 mm, in-pit installation	
8-42400226		Customization kit - PSR 55C CT I, compulsory	
0-42116600/15	230-400V/3Ph/50-60Hz	PSR 55C CT , runway length 5200 mm	
8-42400220		Customization kit - PSR 55C CT, compulsory	
0-42116610/15	230-400V/3Ph/50-60Hz	PSR 55C CT I , runway length 5200 mm, in-pit installation	
8-42400227		Customization kit - PSR 55C CT I, compulsory	

PSR 550C

5500



Main features:

- Capacity: 5.500 kg
- Low profile platform scissor lift for service/inspection.
- Automatic runway levelling system with master/slave hydraulic circuit.
- Runway length: 4600 mm/ 5200 mm



All models supplied with:

- 1 Set of 4 hard rubber blocks.

PN	Power supply	Description	
0-42112300/15	230-400V/3Ph/50-60Hz	PSR 550C , runway length 4600 mm	
8-42400166		Customization kit - PSR 550C, compulsory	
0-42112310/15	230-400V/3Ph/50-60Hz	PSR 550C I , runway length 4600 mm, in-pit installation	
8-42400229		Customization kit - PSR 550C I, compulsory	
0-42116800/15	230-400V/3Ph/50-60Hz	PSR 550C , runway length 5200 mm	
8-42400221		Customization kit - PSR 550C, compulsory	
0-42116810/15	230-400V/3Ph/50-60Hz	PSR 550C I , runway length 5200 mm, in-pit installation	
8-42400230		Customization kit - PSR 550C I, compulsory	

PSR 45C CT LT

WITH LIFT TABLE "LT"

Main features:

- Capacity: 4.500 kg
- Low profile platform scissor lift with lifting table for wheel alignment.
- Automatic runway levelling system with master/slave hydraulic circuit.
- Runway length: 4200 mm

4500



All models supplied with:

- 1 Set of 4 hard rubber blocks.

PN	Power supply	Description	
0-42116100/15	230-400V/3Ph/50-60Hz	PSR 45C CT LT , with LT lift table, runway length 4200 mm	
8-42400167		Customization kit - PSR 45C CT LT, compulsory	
0-42116110/15	230-400V/3Ph/50-60Hz	PSR 45C CT LT I , with LT lift table, runway length 4200 mm, in-pit installation	
8-42400222		Customization kit - PSR 45C CT LT I, compulsory	

PSR 45C CT



Main features:

- Capacity: 4.500 kg
- Low profile platform scissor lift for wheel alignment.
- Automatic runway levelling system with master/slave hydraulic circuit.
- Runway length: 4200 mm



All models supplied with:

- 1 Set of 4 hard rubber blocks.

PN	Power supply	Description	
0-42116200/15	230-400V/3Ph/50-60Hz	PSR 45C CT , runway length 4200 mm	
8-42400168		Customization kit - PSR 45C CT, compulsory	
0-42116210/15	230-400V/3Ph/50-60Hz	PSR 45C CT I , runway length 4200 mm, in-pit installation	
8-42400225		Customization kit - PSR 45C CT I, compulsory	

PSR 450C

Main features:

- Capacity: 4.500 kg
- Low profile platform scissor lift for service/inspection.
- Automatic runway levelling system with master/slave hydraulic circuit.
- Runway length: 4200 mm





All models supplied with:

- 1 Set of 4 hard rubber blocks.

PN	Power supply	Description	
0-42116400/15	230-400V/3Ph/50-60Hz	PSR 450C , runway length 4200 mm	
8-42400170		Customization kit - PSR 450C, compulsory	
0-42116410/15	230-400V/3Ph/50-60Hz	PSR 450C I , runway length 4200 mm, in-pit installation	
8-42400228		Customization kit - PSR 450C I, compulsory	

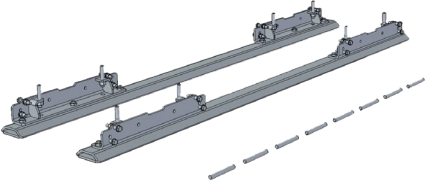
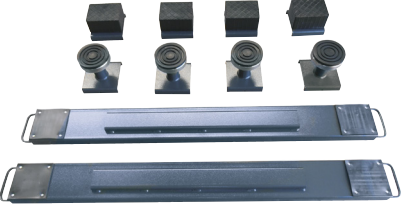
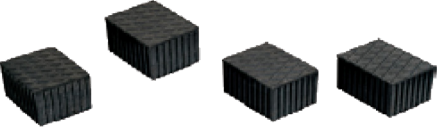
OPTIONAL ACCESSORIES FOR PSR55C AND PSR45C SERIES

Picture	Description	PN	
	<p>Set of cross bars, to be ordered with the lift, compulsory for usage of 2 jacking beams, recommended for wheel alignment, standard colour grey RAL 7016 fixed</p>	8-42100218	
	<p>Off-the-road vehicle cross bar (2 pcs).</p>	8-42300047	
	<p>Kit of 4 rubber blocks height 80 mm.</p>	8-42300027	
	<p>Complete low-voltage lighting kit.</p>	8-42100185	
	<p>Pipe extensions kit L= 2m (for lifts with LT)</p>	8-42100183	
	<p>Pipe extensions kit L= 4m (for lifts with LT)</p>	8-42100184	
	<p>Pipe extensions kit L= 2m (for lifts without LT)</p>	8-42100173	
	<p>Pipe extensions kit L= 4m (for lifts without LT)</p>	8-42100174	

OPTIONAL ACCESSORIES FOR PSR55C AND PSR45C SERIES

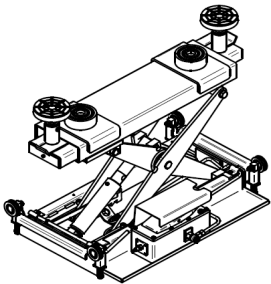
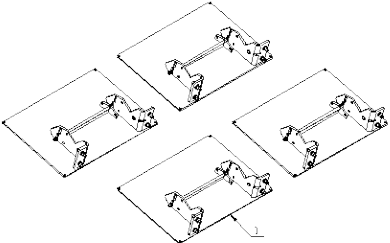
Picture	Description	PN	
	<p><i>Scissor Jack</i> 2,2 ton. Gray Ral 7016.</p>	<p>J804-0000000</p>	
	<p><i>Transformation kit</i> from surface-mounted to recessed installation</p>	<p>8-42100249/00</p>	

PISC 3500.2 EVO

- Electro-hydraulic twin-ram lift, superstructure with two flat lifting supports.
- Portata: 3.500 kg
- For repairs and maintenance
- Waterproof steel cassette

Hydraulic unit:

- Hard-chrome plated cylinder
- Flexible synchronization and safety system
- Corrosion-free guiding elements
- Hydraulic pump unit with immersed motor
- Pneumatic emergency lowering
- Programmable pushbutton control unit

Superstructure:

- Two lifting supports, lengthwise adjustable RAL 9006



10 liter hydraulic oil, viscosity 22,
must be provided by the customer

Code	Electric Supply	Description	
Hydraulic unit and steel cassette supplied separately			
0-48100501/00	230-400V/3PH +N+PE/50Hz/16A	Hydraulic unit for PISC 3500.2 EVO - stroke 1915 mm, compulsory	
8-48400065		Compulsory customization kit for the hydraulic pump unit	
8-48100062		Steel cassette (Piston distance: 1550mm), compulsory	
Hydraulic unit pre-assembled in steel cassette			
0-48100551	230-400V/3PH +N+PE/50Hz/16A	Hydraulic unit for PISC 3500.2 EVO - stroke 1915 mm, pre-assembled from factory in steel cassette	
8-48400065		Compulsory customization kit for the hydraulic pump unit	
Superstructures			
8-48100061/00		Superstructure with flat lifting supports for PISC 3500.2 EVO, lenght 160-220, min. wheel base 2400 mm, including XY heads, compulsory	
8-48400066		Compulsory customization kit for the superstructure	

Each lift is composed by three parts , each of them is compulsory to create a complete machine : hydraulic unit, steel cassette, superstructure

PIDC 35.2 EVO

- Electro-hydraulic twin-ram lift, superstructure with arms.
- Portata: 3.500 kg
- For repairs and maintenance
- Waterproof steel cassette

Hydraulic unit:

- Hard-chrome plated cylinder
- Flexible synchronization and safety system
- Corrosion-free guiding elements
- Hydraulic pump unit with immersed motor
- Pneumatic emergency lowering
- Programmable pushbutton control unit

Superstructure:

- Double telescopic arms (3-stages) RAL 7016
- Internal arm locking system.



3500



10 liter hydraulic oil, viscosity 22,
must be provided by the customer

Code	Electric Supply	Description	
Hydraulic unit and steel cassette supplied separately			
0-48100401/00	230-400V/3PH+N+PE/50Hz/16A	Hydraulic unit for PIDC 35.2 EVO - stroke 1915 mm, compulsory	
8-48400067		Compulsory customization kit for the hydraulic pump unit	
8-48100064		Steel cassette (Piston distance: 1550 mm), compulsory	
Hydraulic unit pre-assembled in steel cassette			
0-48100451	230-400V/3PH+N+PE/50Hz/16A	Hydraulic unit for PIDC 35.2 EVO, stroke 1915 mm, pre-assembled from factory in steel cassette	
8-48400067		Compulsory customization kit for the hydraulic pump unit	
Superstructure			
8-48100063/00		Superstructure with swivel arms for PIDC 35.2 EVO, universal lifting area, min. height 95 mm	
8-48400062		Compulsory customization kit for the superstructure	

Each lift is composed by three parts , each of them is compulsory to create a complete machine : hydraulic unit, steel cassette, superstructure

PIDC 55.2

- Electro-hydraulic twin-ram lift, superstructure with arms.
- Portata: 5.500 kg
- For repairs and maintenance
- Waterproof steel cassette

Hydraulic unit:

- Hard-chrome plated cylinder
- Flexible synchronization and safety system
- Corrosion-free guiding elements
- Hydraulic pump unit with immersed motor
- Pneumatic emergency lowering
- Programmable pushbutton control unit

Superstructure:

- Double telescopic arms (3-stages) RAL 7016
- Internal arm locking system.

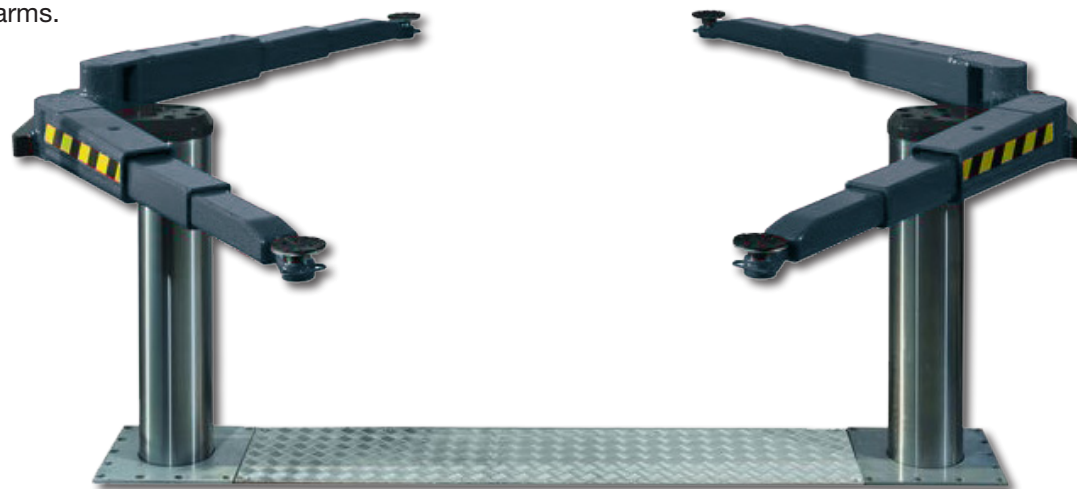

5500



17 liter hydraulic oil, viscosity 22, must be provided by the customer







Each lift is composed by three parts , each of them is compulsory to create a complete machine : hydraulic unit, steel cassette, superstructure

Code	Electric Supply	Description	
Hydraulic unit and steel cassette supplied separately			
0-48100301/64	230-400V/3PH +N+PE/50Hz/16A	Hydraulic unit for PIDC 55.2 - stroke 1860 mm, compulsory	
8-48400004		Compulsory customization kit for the hydraulic pump unit	
8-48100018		Steel cassette (L=2150 mm - H= 2455 mm), compulsory	
Hydraulic unit pre-assembled in steel cassette			
0-48100351	230-400V/3PH +N+PE/50Hz/16A	Hydraulic unit for PIDC 55.2 - stoke 1860 mm, pre-assembled from factory in steel cassette	
8-48400004		Compulsory customization kit for the hydraulic pump unit	
Superstructure			
8-48100055/64		Superstructure with swivel arms for PIDC 55.2, universal lifting area, Ø50 mm hole for lifting pads, with Ø50-40 mm reducers, min. height 135 mm, compulsory	
8-48400033		Compulsory customization kit for the superstructure	

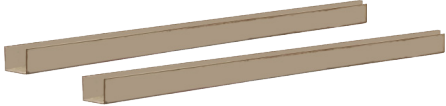



COMPULSORY ACCESSORIES

Image	Description	Code		PISC 3500.2 EVO	PIDC 35.2 EVO	PIDC 55.2
	Set of cables 10m	8-48100006		○	○	○

OPTIONAL ACCESSORIES





Image	Description	Code		PISC 3500.2 EVO	PIDC 35.2 EVO	PIDC 55.2
	U-Profile Traverse of installation of inground lift steel cassette 160x85x2000 (reusable, 2 pcs are needed for 1 cassette)	8-48100080		○	○	
	U-Profile Traverse of installation of inground lift steel cassette 160x85x2000 (reusable, 2 pcs are needed for 1 cassette)	NX1208101				○
	Kit of 4 e-car adapters for ø50 mm pick-up	8-48100075			○	○
	Rubber blocks 40mm, 120x120xØ100, (1 set = 4 pcs) RECOMMENDED	8-48100008		○		
	Rubber blocks 60 mm, 1 set = 4 pieces	8-48100010		○		
 x1	Lifting pad extension 50mm - Ø50mm – 1 piece	8-48100057			○	○
 x1	Lifting pad extension 100mm - Ø50mm – 1 piece	8-48100058			○	○

OPTIONAL ACCESSORIES

Image	Description	Code		PISC 3500.2 EVO	PIDC 35.2 EVO	PIDC 55.2
	Lifting pad single-telescopic $\varnothing 120/\varnothing 50$ max 4 ton. - working range 78-110 mm (1 piece)	8-48100069			○	
	Lifting pad double-telescopic $\varnothing 120/\varnothing 50$ max 4 ton. - working range 95-174 mm (1 piece)	8-48100070			○	
	Lifting pad single telescopic, working range 147-238mm, for lifts with max. lift capacity 6500 kg, for $\varnothing 50$ mm pick-up hole (1 piece)	8-48100077				○
 x4	Manual unlocking system for 3.5 t Saa, 1set = 4 pcs	8-48100022			○	
	Multi-quick adapter	NX1316064				○

NEW!

OPTIONAL ACCESSORIES

Image	Description	Code		PISC 3500.2 EVO	PIDC 35.2 EVO	PIDC 55.2
 x4	Kit of 4 wheel support adapters , excentric pick-up, max. 1000 kg for each adapter for ø50mm pick-up hole	8-48100073			○	
IMAGE NOT AVAILABLE	Kit of 4 reducers for wheel support adapters [- ø 600 mm]	8-48100074			○	
 x4	Kit of 4 wheel support adapters , centred pick-up ø50 mm, max. 1500 kg for each adapter for ø50mm pick-up hole	8-48100078				○
IMAGE NOT AVAILABLE	Reducer ø50 -> ø40 , for the use of ø40mm insert size lifting pads in arms with an insert diameter of ø50mm, 1 piece	8-48100079				○
 x2	Rubber drive-on support (50x500x1000mm) 1 kit = 2 pcs	8-48100026			○	○
 x2	Set of lifting pads Crafter/Sprinter 1 Set = 2 pieces, pin-shape for ø40mm pick-up hole	8-48100029				○
	Set of lifting pads "Crafter/Sprinter" 1 Set = 2 pieces, V-shape for ø40mm pick-up hole	8-48100030				○

PSC 3000/ 3500/ 4000 SERIES



3000



3500



4000



Image	Electric Supply	Description	
CONFIGURATOR UNIQUE CODE 0-410001			
Loading Capacity 3000 kg.	230-400V/ 3Ph/ 50-60Hz	PSC 3000 FS with flaps and mechanical safety lock.	
	230-400V/ 3Ph/ 50-60Hz	PSC 3000 F with flaps and double master/slave.	
Loading Capacity 3500 kg.	230-400V/ 3Ph/ 50-60Hz	PSC 3500 FS with flaps and mechanical safety lock.	
	230-400V/ 3Ph/ 50-60Hz	PSC 3500 S with extension runways and mechanical safety lock.	
	230-400V/ 3Ph/ 50-60Hz	PSC 3500 F with flaps and double master/slave.	
	230-400V/ 3Ph/ 50-60Hz	PSC 3500 with extension runways and double master/slave.	
Loading Capacity 4000 kg.	230-400V/ 3Ph/ 50-60Hz	PSC 4000 S with extension runways and mechanical safety lock.	

Installation Mode	
On-floor <i>installation</i>	
In-pit <i>installation</i>	
Neutral Version	



Alternative Configurations	
Voltage: 230V/1Ph/50-60Hz	
Hydraulic Oil	
Special Color 1: new color instead of usual red color RAL 3002 (grey color RAL 7016 remain unchanged).	
Special Color 2: new colors instead of usual combination red color RAL 3002 + grey color RAL 7016	

As a completion of the installation with Neutral Version, one the four accessories highlighted in green color has to be purchased (see "Accessories for completion of Neutral Installation")

Accessories for completion of neutral installation

OPTIONAL ACCESSORIES			PSC 3000 FS	PSC 3000 FSJ	PSC 3000 F	PSC 3000 FI	PSC 3500 FS	PSC 3500 FSJ	PSC 3500 S	PSC 3500 SJ	PSC 3500 F	PSC 3500 FI	PSC 3500	PSC 3500 I	PSC 4000 S	PSC 4000 SJ
<i>Image</i>	<i>Description</i>	<i>Code</i>														
IMAGE NOT AVAILABLE	On-floor installation kit (neutral version) when ordering a lift with extensions	8-41120001	-	-	-	-	-	-	O	-	-	-	O	-	O	-
IMAGE NOT AVAILABLE	In-pit installation kit (neutral version) when ordering a lift with extensions	8-41120002	-	-	-	-	-	-	-	O	-	-	-	O	-	O
IMAGE NOT AVAILABLE	On-floor installation kit (neutral version) when ordering a lift with flaps	8-41120003	-	-	-	-	O	-	-	-	O	-	-	-	-	-
IMAGE NOT AVAILABLE	In-pit installation kit (neutral version) when ordering a lift with flaps	8-41120004	O	O	O	O	-	O	-	-	-	O	-	-	-	-

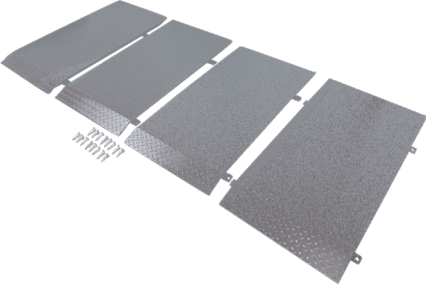
OPTIONAL ACCESSORIES

Image	Description	Code		PSC 3000 FS	PSC 3000 FSI	PSC 3000 F	PSC 3000 FI	PSC 3500 FS	PSC 3500 FSI	PSC 3500 S	PSC 3500 SI	PSC 3500 F	PSC 3500 FI	PSC 3500	PSC 3500 I	PSC 4000 S	PSC 4000 SI
	Set of long ramps for on-floor version H=50 , for PSC3500 S, PSC3500, PSC4000 S	8-41100206		-	-	-	-	-	-	O	-	-	-	O	-	O	-
	Set of long ramps for on-floor version H=50 , for PSC3000 FS, PSC3000 F, PSC3500 FS	8-41100207		O	-	O	-	O	-	-	-	O	-	-	-	-	-
	Extensions for pipes and cables, 1 mt. (cables and protection cover included).	8-41100145		-	-	O	O	-	-	-	-	O	O	O	O	-	-
	Extensions for pipes and cables, 2 mt. (cables and protection cover included).	8-41100146		-	-	O	O	-	-	-	-	O	O	O	O	-	-
	Extensions for pipes and cables, 1 mt. (cables and protection cover included).	8-41100149		O	O	-	-	O	O	O	O	-	-	-	-	O	O
	Extensions for pipes and cables, 2 mt. (cables and protection cover included).	8-41100150		O	O	-	-	O	O	O	O	-	-	-	-	O	O

OPTIONAL ACCESSORIES

<i>Image</i>	<i>Description</i>	<i>Code</i>		PSC 3000 FS	PSC 3000 FSI	PSC 3000 F	PSC 3000 FI	PSC 3500 FS	PSC 3500 FSI	PSC 3500 S	PSC 3500 SI	PSC 3500 F	PSC 3500 FI	PSC 3500	PSC 3500 I	PSC 4000 S	PSC 4000 SI
Civil Works - research codes for the website private area - only for IN-PIT versions																	

PSC 3000E/ 3500E SERIES ECO-LINE



3000



3500





“Eco” models: double Master-Slave system, no electronics on scissor side, oil included

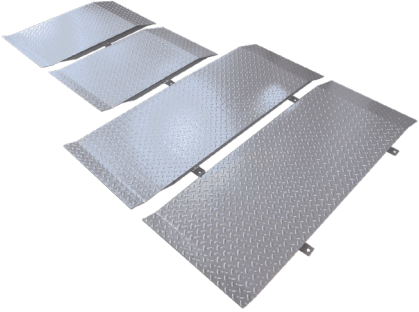
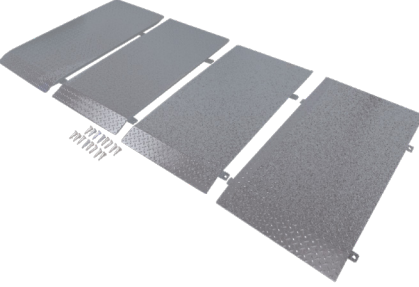

Code	Electric Supply	Description	
0-41402110/15	230-400V/3PH/50-60Hz	PSC3000E double master-slave system, no electronics on scissors side, on-flor installation, 600 mm extensions, min heigt 105 mm (oil included)	
0-41402112/15	230V/1PH/50Hz	PSC3000E double master-slave system, no electronics on scissors side, on-flor installation, 600 mm extensions, min heigt 105 mm (oil included)	
0-41402160/15	230-400V/3PH/50-60Hz	PSC3000E I double master-slave system, no electronics on scissors side, in-pit installation, 600 mm extensions (oil included)	
0-41402162/15	230V/1PH/50Hz	PSC3000E I double master-slave system, no electronics on scissors side, in-pit installation, 600 mm extensions (oil included)	
0-41402100/15	230-400V/3PH/50-60Hz	PSC3000E F double master-slave system, no electronics on scissors side, on-flor installation, 285 mm short ramps, min height 105 mm (oil included)	

Code	Electric Supply	Description	
0-41402102/15	230V/1PH/50Hz	PSC3000E F double master-slave system, no electronics on scissors side, on-floor installation, 285 mm short ramps, min height 105 mm (oil included)	
0-41402150/15	230-400V/3PH/50-60Hz	PSC3000E F I double master-slave system, no electronics on scissors side, in-pit-installation, 285 mm short ramps (oil included)	
0-41402152/15	230V/1PH/50Hz	PSC3000E F I double master-slave system, no electronics on scissors side, in-pit-installation, 285 mm short ramps (oil included)	
0-41402010/15	230-400V/3PH/50-60Hz	PSC3500E double master-slave system, no electronics on scissors side, on-floor installation, 600 mm extensions, min height 115 mm (oil included)	
0-41402012/15	230V/1PH/50Hz	PSC3500E double master-slave system, no electronics on scissors side, on-floor installation, 600 mm extensions, min height 115 mm (oil included)	
0-41402060/15	230-400V/3PH/50-60Hz	PSC3500E I double master-slave system, no electronics on scissors side, in-pit installation, 600 mm extensions (oil included)	
0-41402062/15	230V/1PH/50Hz	PSC3500E I double master-slave system, no electronics on scissors side, in-pit installation, 600 mm extensions (oil included)	
0-41402000/15	230-400V/3PH/50-60Hz	PSC3500E F double master-slave system, no electronics on scissors side, on-floor installation, 285 mm short ramps, min height 115 mm (oil included)	
0-41402002/15	230V/1PH/50Hz	PSC3500E F double master-slave system, no electronics on scissors side, on-floor installation, 285 mm short ramps, min height 115 mm (oil included)	
0-41402050/15	230-400V/3PH/50-60Hz	PSC3500E F I double master-slave system, no electronics on scissors side, in-pit installation, 285 mm short ramps, min height 115 mm (oil included)	
0-41402052/15	230V/1PH/50Hz	PSC3500E F I double master-slave system, no electronics on scissors side, in-pit installation, 285 mm short ramps, min height 115 mm (oil included)	

OPTIONAL ACCESSORIES

Image	Description	Code		PSC 3000E	PSC 3000E I	PSC 3000E F	PSC 3000E F I	PSC 3500E	PSC 3500E I	PSC 3500E F	PSC 3500E F I
	Anchor bolt kit (8 pcs.)	8-41100203		○	○	○	○	○	○	○	○
	Set of long ramps for on-floor version H=50	8-41100206		○	-	-	-	○	-	-	-
	Set of long ramps for on-floor version H=50	8-41100207		-	-	○	-	-	-	○	-
	Extensions for pipes and cables, 1 mt. (cables and protection cover included)	8-41100159		○	○	○	○	○	○	○	○
	Extensions for pipes and cables, 2 mt. (cables and protection cover included)	8-41100160		○	○	○	○	○	○	○	○

OPTIONAL ACCESSORIES

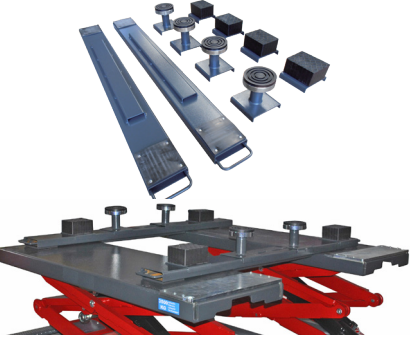
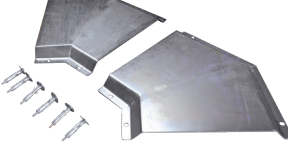
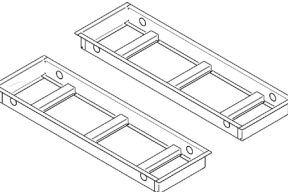
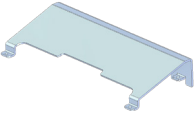
Image	Description	Code		PSC 3000E	PSC 3000E I	PSC 3000E F	PSC 3000E F I	PSC 3500E	PSC 3500E I	PSC 3500E F	PSC 3500E F I
	Kit of 4 rubber blocks height 80 mm.	8-42300027		○	○	○	○	○	○	○	○
	Kit of 4 rubber blocks height 40 mm.	8-42300028		○	○	○	○	○	○	○	○
	Off-the-road vehicle cross bar (2 pcs).	8-42300047		○	○	○	○	○	○	○	○
	Angle pipe <i>protection cover</i> .	8-41100143		○	-	○	-	○	-	○	-
	Frame set	8-41100166		-	○	-	-	-	○	-	-
	Frame set to be ordered together with P/N 8-41100165	8-41100167		-	-	-	○	-	-	-	○
 x4	Support for flaps kit for in-pit installation kit <i>Mandatory for recessed installation</i>	8-41100165		-	-	-	○	-	-	-	○

PSC 3200C EF

Main features:

- Capacity: 3.200 kg.
- Alignment of the runways with a dual MASTER/SLAVE circuit without mechanical safety racks.
- Runboards version with flaps (F).

25 liter hydraulic oil, viscosity 32, must be provided by the customer.



All models supplied with:

- 1 Set of 4 hard rubber blocks.

PN	Power supply	Description	
0-41106000/15	230V/400V - 3PH - 50/60HZ	PSC 3200C EF - Red RAL 3002 Orange peel - Capacity 3.200 kg.	
0-41106002/15	230V/1Ph/50Hz	PSC 3200C EF - Red RAL 3002 Orange peel - Capacity 3.200 kg.	
0-41106003/15	230V/1Ph/60Hz	PSC 3200C EF - Red RAL 3002 Orange peel - Capacity 3.200 kg.	
8-41400189		Customization kit for PSC 3200C EF (Compulsory)	

PSC 3600C EF

Main features:

- Capacity: 3.600 kg.
- Alignment of the runways with a dual MASTER/SLAVE circuit without mechanical safety racks.
- Runboards version with flaps (F).

25 liter hydraulic oil, viscosity 32, must be provided by the customer.



All models supplied with:

- 1 Set of 4 hard rubber blocks.

PN	Power supply	Description	
0-41106100/15	230V/400V - 3PH - 50/60HZ	PSC 3600C EF - Red RAL 3002 Orange peel - Capacity 3.600 kg.	
0-41106102/15	230V/1Ph/50Hz	PSC 3600C EF - Red RAL 3002 Orange peel - Capacity 3.600 kg.	
0-41106103/15	230V/1Ph/60Hz	PSC 3600C EF - Red RAL 3002 Orange peel - Capacity 3.600 kg.	
8-41400190		Customization kit for PSC 3600C EF (Compulsory)	

COMPULSORY ACCESSORIES FOR PSC 3200C EF AND PSC 3600C EF

Picture	Description	PN	
	<p>Set of masonry screws (8 pcs.) For all models in the range.</p>	8-41100203	

OPTIONAL ACCESSORIES FOR PSC 3200C EF AND PSC 3600C EF

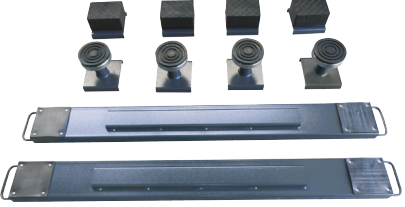
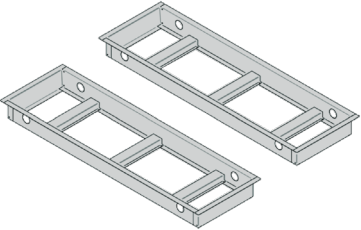
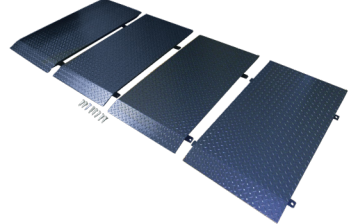
Picture	Description	PN	
	<p>Off-the-road vehicle cross bar (2 pcs).</p>	8-42300047	
	<p>Flush installation frame set (galvanized) for C-line underbody low profile double scissor lifts with flaps (MUST BE COMBINED WITH 8-41100165)</p>	8-41100225	
	<p>Set of long ramps for on-floor version</p>	8-41100207	

OPTIONAL ACCESSORIES FOR PSC 3200C EF AND PSC 3600C EF

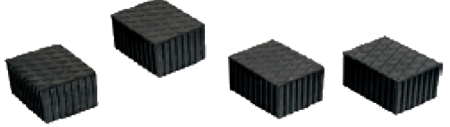
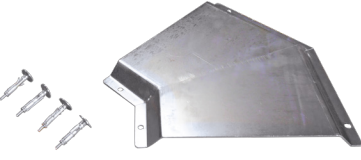
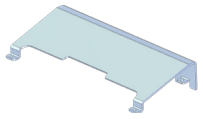
Picture	Description	PN	
	<p>Extensions for pipes and cables, 1 mt. (cables and protection cover included)</p>	8-41100159	
	<p>Extensions for pipes and cables, 2 mt. (cables and protection cover included)</p>	8-41100160	
	<p>Kit of 4 rubber blocks height 80 mm.</p>	8-42300027	
	<p>Angle pipe protection cover</p>	8-41100143	
 <p>x4</p>	<p>Support for flaps kit for in-pit installation kit Mandatory for recessed installation</p>	8-41100165	

PSCA 35 T -IN-PIT VERSION

PSCA 40 T -IN-PIT VERSION



3500



4000



Code	Electric Supply	Description	
0-41400301/15	400V/ 3Ph/ 50-60Hz	PSCA 35T in-pit version, extension runways.	
0-41400302/15	230V/ 1Ph/ 50-60Hz	PSCA 35T in-pit version, extension runways.	
0-41400401/15	400V/ 3Ph/ 50-60Hz	PSCA 40T in-pit version, extension runways.	
0-41400402/15	230V/ 1Ph/ 50-60Hz	PSCA 40T in-pit version, extension runways.	

PSCA 35E - INCASSO ECO-LINE

PSCA 40E - INCASSO ECO-LINE



3500





4000



“Eco” models: double Master-Slave system, no electronics on scissor side, oil included

Code	Electric Supply	Description	
0-41402200/15	230-400V/3PH/50-60Hz	PSCA35E double master-slave system, no electronics on scissors side, in-pit installation, 600 mm extensions (oil included)	
0-41402202/15	230V/1PH/50-60Hz	PSCA35E double master-slave system, no electronics on scissors side, in-pit installation, 600 mm extensions (oil included)	
0-41402210/15	230-400V/3PH/50-60Hz	PSCA40E double master-slave system, no electronics on scissors side, in-pit installation, 600 mm extensions (oil included)	
0-41402212/15	230V/1PH/50-60Hz	PSCA40E double master-slave system, no electronics on scissors side, in-pit installation, 600 mm extensions (oil included)	
Hot dip galvanizing treatment on the lift			
Hot dip galvanizing treatment on accessories			
Extra-charge for special colors			

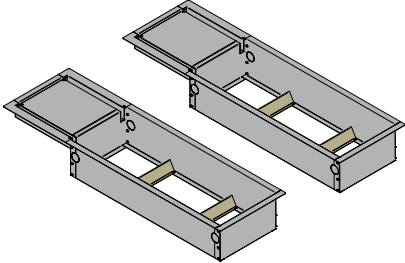
OPTIONAL ACCESSORIES - PSCA 35T - 35E - 40T - 40E - IN-PIT VERSION

Image	Description	Code		PSCA 35T	PSCA 40T	PSCA 35E	PSCA 40E
	Anchor bolt <i>kit</i> (8 pcs.)	8-41100203		O	O	O	O
	Frame set for PSCA 35T in-pit installation, 2 pcs.	8-41100172		O	-	O	-
	Frame set for PSCA 40T in-pit installation, 2 pcs.	8-41100171		-	O	-	O
	Extensions for pipes and cables, 1 mt.	8-41100184				O	O
	Extensions for pipes and cables, 2 mt.	8-41100185				O	O
	Extensions for pipes and cables, 1 mt.	8-41100131		O	O		
	Extensions for pipes and cables, 2 mt.	8-41100132		O	O		

OPTIONAL ACCESSORIES - PSCA 35T - 35E - 40T - 40E - IN-PIT VERSION

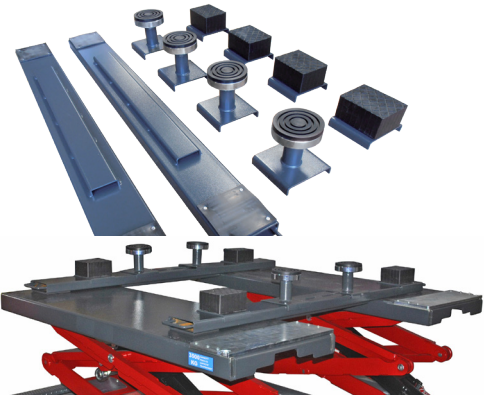
Image	Description	Code		PSCA 35T	PSCA 40T	PSCA 35E	PSCA 40E
	<p>Set of 4 pads, H=80 mm.</p>	<p>8-42300027</p>		<p>O</p>	<p>O</p>		
	<p>Pair of beams for all-terrain vehicles, L=1800 mm.</p>	<p>8-42300047</p>		<p>O</p>	<p>O</p>		

PSCA 36C T E

Main features:

- Capacity: 3.600 kg.
- Alignment of the runways with a dual MASTER/SLAVE circuit without mechanical safety racks.

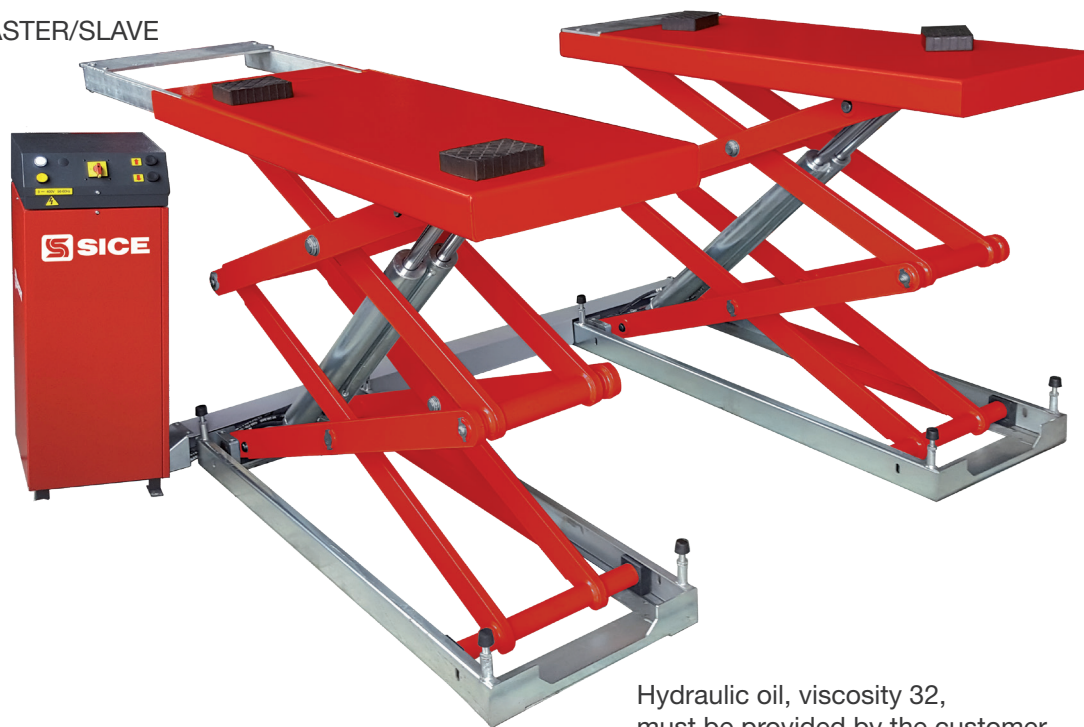

All models supplied with:
- 1 Set of 4 hard rubber blocks.

Hydraulic oil, viscosity 32,
must be provided by the customer

PN	Power supply	Description	
0-41106300/15	230V/400V - 3PH - 50/60HZ	PSCA 36C T E - Red RAL 3002 Orange peel - Capacity 3.600 kg.	
0-41106302/15	230V/1Ph/50Hz	PSCA 36C T E - Red RAL 3002 Orange peel - Capacity 3.600 kg.	
0-41106303/15	230V/1Ph/60Hz	PSCA 36C T E - Red RAL 3002 Orange peel - Capacity 3.600 kg.	
8-41400192		Customization kit for PSCA 36C T E (Compulsory)	

PSCA 40C T E

Main features:

- Capacity: 4.000 kg.
- Alignment of the runways with a dual MASTER/SLAVE circuit without mechanical safety racks.

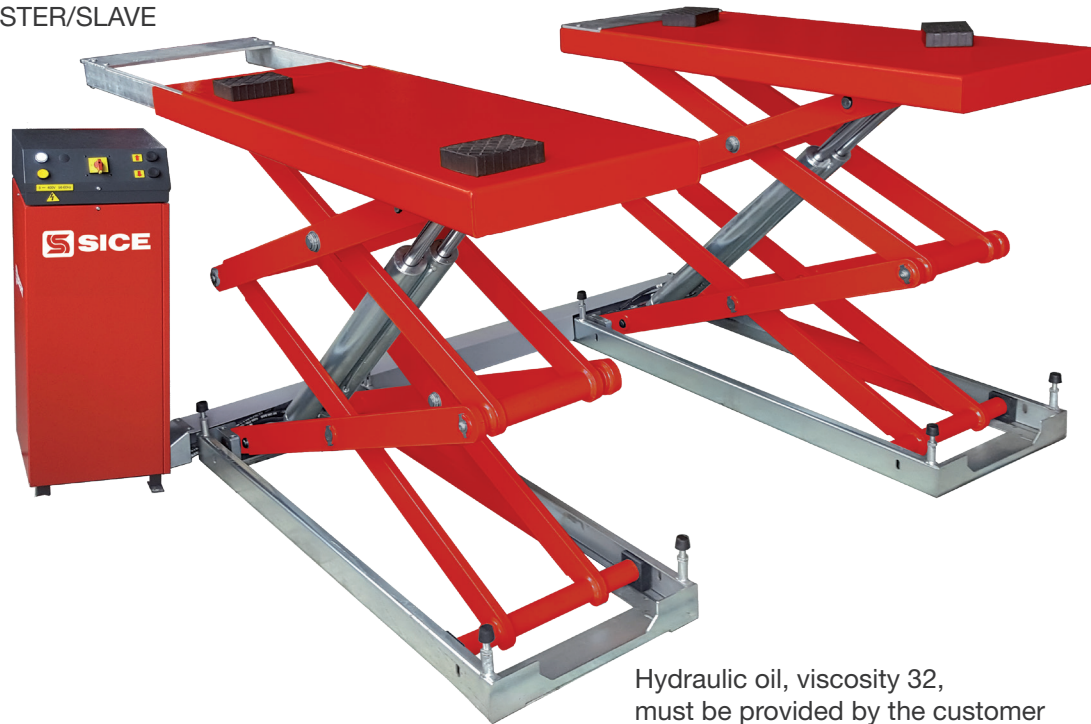

All models supplied with:

- 1 Set of 4 hard rubber blocks.



Hydraulic oil, viscosity 32, must be provided by the customer

PN	Power supply	Description	
0-41106400/15	230V/400V - 3PH - 50/60HZ	PSCA 40C T E - Red RAL 3002 Orange peel - Capacity 4.000 kg.	
0-41106402/15	230V/1Ph/50Hz	PSCA 40C T E - Red RAL 3002 Orange peel - Capacity 4.000 kg.	
0-41106403/15	230V/1Ph/60Hz	PSCA 40C T E - Red RAL 3002 Orange peel - Capacity 4.000 kg.	
8-41400193		Customization kit for PSCA 40C T E (Compulsory)	

COMPULSORY ACCESSORIES FOR PSCA 36C T E, AND PSCA 40C T E

Picture	Description	PN	
	Set of masonry screws (8 pcs.) For all models in the range.	8-41100203	

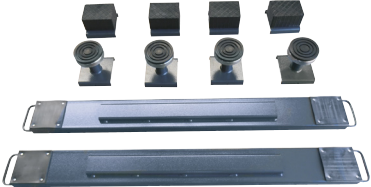
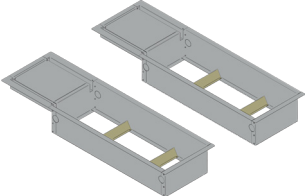
OPTIONAL ACCESSORIES FOR PSCA 36C T E, AND PSCA 40C T E

Picture	Description	PN	
	Off-the-road vehicle cross bar (2 pcs).	8-42300047	
	Flush installation frame set (2 pcs) for lifts with 3.6 t capacity	8-41100204	
	Flush installation frame set (2 pcs) for lifts with 4.0 t capacity	8-41100242	
	Extensions for pipes and cables L=1 mt.	8-41100184	
	Extensions for pipes and cables L = 2 mt. (protection covers included.)	8-41100185	
	Kit of 4 rubber blocks height 80 mm.	8-42300027	

UNDERBODY SINGLE SCISSOR LIFTS - LOW PROFILE

PSCE 300 PSCE 305



3000



3500



	<i>Electric Supply</i>	<i>Description</i>	
0-410002	CONFIGURATOR UNIQUE CODE		
LOADING CAPACITY 3000 kg.	230-400V/ 3Ph/ 50-60Hz	PSCE 300 with extension runways and double master/slave circuit.	
	230-400V/ 3Ph/ 50-60Hz	PSCE 300 F with runways with flaps and double master/slave.	
LOADING CAPACITY 3500 kg.	230-400V/ 3Ph/ 50-60Hz	PSCE 305 with extension runways and double master/slave circuit.	
	230-400V/ 3Ph/ 50-60Hz	PSCE 305 F with runways with flaps and double master/slave.	

Installation Mode	
ON-FLOOR <i>Installation</i>	
IN-PIT <i>Installation</i>	
Neutral Version	





Alternative Configurations	
Voltage: 230V/1Ph/50-60Hz	
Hydraulic Oil	
Special Color #1: new color instead of usual red color RAL 3002 (grey color RAL 7016 remain unchanged)	
Special Color #2: new colors instead of usual combination red color RAL 3002 + grey color RAL 7016	

As a completion of the installation with Neutral Version, one the four accessories highlighted in green color has to be purchased (see "Accessories for completion of Neutral Installation")

Accessories for completion of neutral installation

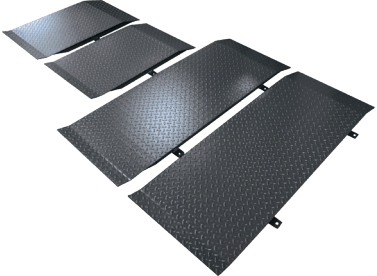
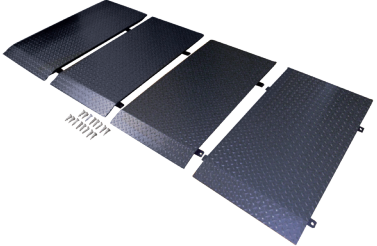
OPTIONAL ACCESSORIES				PSOE 300	PSOE 300F	PSOE 300 FI	PSOE 300 I	PSOE 305	PSOE 305 F	PSOE 305 FI	PSOE 305 I
Image	Description	Code									
IMAGE NOT AVAILABLE	On-floor installation kit (neutral version) when ordering a lift with extensions	8-41100157		O	-	-	-	O	-	-	-
IMAGE NOT AVAILABLE	In-pit installation kit (neutral version) when ordering a lift with extensions	8-41100155		-	-	-	O	-	-	-	O
IMAGE NOT AVAILABLE	On-floor installation kit (neutral version) when ordering a lift with flaps	8-41100158		-	O	-	-	-	O	-	-
IMAGE NOT AVAILABLE	In-pit installation kit (neutral version) when ordering a lift with flaps	8-41100156		-	-	O	-	-	-	O	-

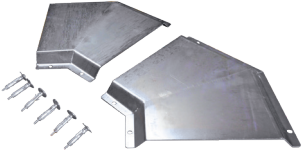
OPTIONAL ACCESSORIES

Image	Description	Code		PSCE 300	PSCE 300F	PSCE 300 FI	PSCE 300 I	PSCE 305	PSCE 305 F	PSCE 305 FI	PSCE 305 I
	Set of long ramps for on-floor version H=50, for PSCE300 and PSCE305	8-41100208		O	-	-	-	O	-	-	-
	Set of long ramps for on-floor version H=50, for PSCE300F and PSCE305F	8-41100209		-	O	-	-	-	O	-	-
	Extensions for pipes and cables, 1 mt. (cables and protection cover included)	8-41100159		O	O	O	O	O	O	O	O
	Extensions for pipes and cables, 2 mt. (cables and protection cover included)	8-41100160		O	O	O	O	O	O	O	O
	Angle pipe protection cover .	8-41100143		O	O	-	-	O	O	-	-
	Kit of 4 rubber blocks height 80 mm.	8-42300027		O	O	O	O	O	O	O	O

OPTIONAL ACCESSORIES

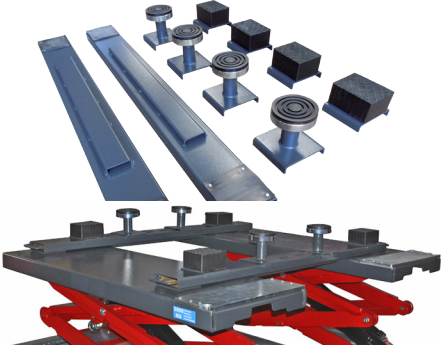
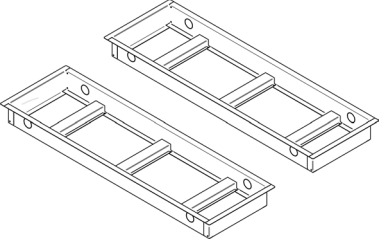
Image	Description	Code		PSCE 300	PSCE 300F	PSCE 300 FI	PSCE 300 I	PSCE 305	PSCE 305 F	PSCE 305 FI	PSCE 305 I
	Kit of 4 rubber blocks height 40 mm.	8-42300028		○	○	○	○	○	○	○	○
	Off-the-road vehicle cross bar (2 pcs).	8-42300047		○	○	○	○	○	○	○	○
	Frame set for recessing for PSCE 300I and PSCE 305I	8-41100170					○				○
	Frame set for recessing for PSCE 300FI and PSCE 305FI	8-41100169				○			○		

Civil Works - research codes for the website private area - only for IN-PIT versions

0-410002PSCE300I

0-410002PSCE300FI

0-410002PSCE305I

0-410002PSCE305FI

PSCE 350C B

Main features:

- Capacity: 3.500 kg.
- Reversible low-profile electrohydraulic scissors lift for cars, SUVs and vans
- Robust structure of scissors, offering great lateral stability
- Alignment ensured by two robust anti-torsion bars
- Hot galvanized base as standard, painted scissors, runways and ramps
- Start lever from zero position to maximum height

3500



All models supplied with:



- 1 Set of 4 hard rubber blocks.

PN	Power supply	Description	
0-41107500/15	230V/400V - 3PH - 50/60HZ	PSCE 350C B	
0-41107502/15	230V/1Ph/50Hz	PSCE 350C B	
0-41107503/15	230V/1Ph/60Hz	PSCE 350C B	
8-41400227		Customization kit for PSCE 350C B (Compulsory)	

COMPULSORY ACCESSORIES FOR PSCE 350C B

<i>Picture</i>	<i>Description</i>	<i>PN</i>	
	<i>Anchor kit</i> (8 pcs.)	8-41100229	

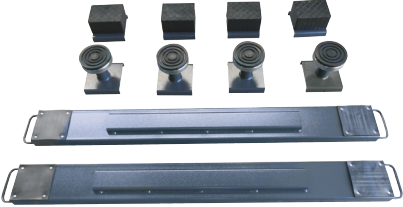
OPTIONAL ACCESSORIES FOR PSCE 350C B

Picture	Description	PN	
	<p><i>Lift movimentation</i> kit</p>	<p>8-41100228</p>	
	<p><i>Crossbar set</i> (2 bars and 4 pads), L=1800 mm.</p>	<p>8-42300047</p>	
	<p><i>Pad set</i> (4 pcs.) H = 80 mm.</p>	<p>8-42300027</p>	

PDC 30

3000



Code	Electric Supply	Description	
0-43102101/15	400V/ 3Ph/ 50-60Hz	PDC 30 with NON load-bearing base, chain drive system and asymmetric arms	
0-43102111/15	230/ 3Ph/ 50-60Hz	PDC 30 with NON load-bearing base, chain drive system and asymmetric arms	
8-43100169		Customization kit.	

COMPULSORY ACCESSORIES - PDC 30

<i>Image</i>	<i>Description</i>	<i>Code</i>	
	<i>Anchor set</i> (4+4 pezzi).	8-43100151	

OPTIONAL ACCESSORIES - PDC 30

<i>Image</i>	<i>Description</i>	<i>Code</i>	
	<i>Pad extension set</i> (4 pcs.) H=150 mm.	8-43100153	

PDC 32N

3200

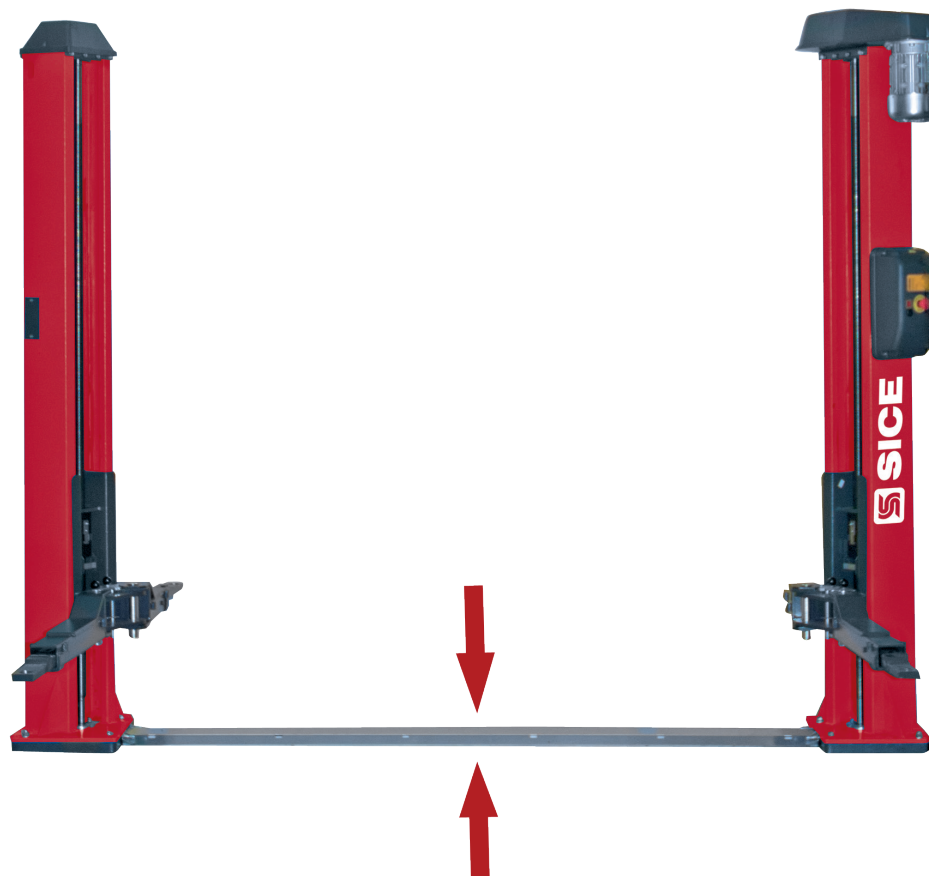
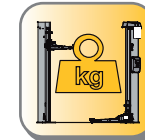

Code	Electric Supply	Description	
0-43400900/15	400V/ 3Ph/ 50Hz	PDC 32N , chain drive system and asymmetric arms.	
0-43400901/15	230V/ 3Ph/ 50Hz	PDC 32N , chain drive system and asymmetric arms.	
0-43400910/15	400V/ 3Ph/ 50Hz	PDC 32N CBP , with base, chain drive system and asymmetric arms.	
0-43400911/15	230V/ 3Ph/ 50Hz	PDC 32N CBP , with base, chain drive system and asymmetric arms.	

PDC 32N CEL

3200



Code	Electric Supply	Description	
0-43400800/15	400V/ 3Ph/ 50Hz	PDC 32N CEL asymmetric arms, 2 motors and electronic synchronization system.	
0-43400801/15	230V/ 3Ph/ 50Hz	PDC 32N CEL asymmetric arms, 2 motors and electronic synchronization system.	

PDC 40N CEL

4000



Code	Electric Supply	Description	
0-43400010/15	400V/ 3Ph/ 50-60Hz	PDC 40N CEL , asymmetric arms, 2 motors and electronic synchronization system.	
0-43400011/15	230V/ 3Ph/ 50-60Hz	PDC 40N CEL , asymmetric arms, 2 motors and electronic synchronization system.	

PDC 40 ELX

4000

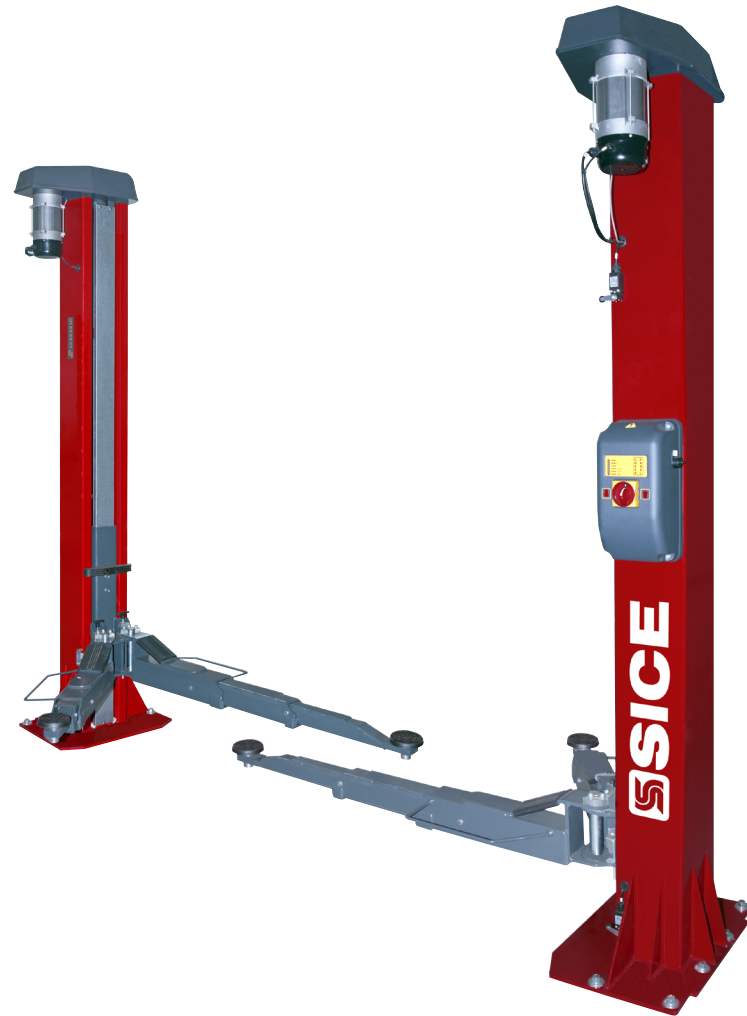
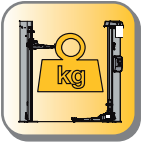

Code	Electric Supply	Description	
0-43400700/15	400V/ 3Ph/ 50Hz	PDC 40 ELX, symmetric arms, 2 motors and electronic synchronization system, anchor bolts included.	



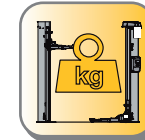

PDC 50

5000







Code	Electric Supply	Description	
0-43103201/15	400V/ 3Ph/ 50Hz	PDC 50, symmetric arms, 2 motors and electronic synchronization system, anchor bolts included.	

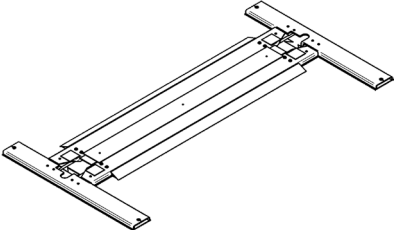

COMPULSORY ACCESSORIES - PDC 32N - 40N - PDC 40 ELX - PDC 50

Image	Description	Code		PDC 32N	PDC 32N CBP	PDC 32N CEL	PDC 40N CEL	PDC 40 ELX	PDC 50 CEL
	Ground fixing kit.	8-43300182		O	-	-	-	-	-
	Ground fixing kit.	8-43300186		-	-	O	-	-	-
	Ground fixing kit.	8-43300183		-	O	-	-	-	-
	Ground fixing kit.	8-43300184		-	-	-	O	-	-
IMMAGINE NON DISPONIBILE	3,2 tons short arms kit for FERRARI.	8-43320000		-	-	O	-	-	-

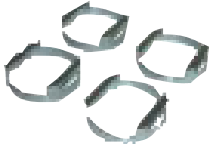
OPTIONAL ACCESSORIES - PDC 32N-PDC 40N-PDC 40 ELX-PDC 50

Image	Description	Code		PDC 32N	PDC 32N CBP	PDC 32N CEL	PDC 40N CEL	PDC 40 ELX	PDC 50
	Complete pad kit for FCA electric cars (1 pc) Ø 60mm, designed for FIAT 500 electric version	8-43100229		○	○	○	○	○	○
	Base kit. (To be ordered only in case the floor has not the minimum necessary features and it is not possible to make building works)	8-43300185		○	-	○	-	-	-
	Set of 4 extension for pads, H=35 mm.	8-43300021		○	○	○	○	○	○
IMMAGINE NON DISPONIBILE	Set of 4 extension for pads, H=80 mm.	8-43300014		-	-	-	○	-	-
	Set of 4 extension for pads, H=140 mm.	8-43300015		○	○	○	○	○	○
	Set of 4 adapters for Mercedes Sprinter.	8-43300016		○	○	○	○	○	○
	Set of 4 special supports for 4WD vehicles.	8-43300017		○	○	○	○	○	○

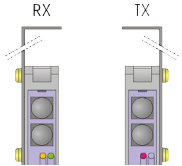
OPTIONAL ACCESSORIES - PDC 32N-PDC 40N-PDC 40 ELX-PDC 50

Image	Description	Code		PDC 32N	PDC 32N CBP	PDC 32N CEL	PDC 40N CEL	PDC 40 ELX	PDC 50
	Additional photocell kit.	8-43300003		-	-	O	O	O	O
	Roof cable guide for PDC 32N CEL H=3840 mm	8-43300037		-	-	O	-	-	-
	Roof cable guide for PDC 40 N H=4540 mm	8-43300036		-	-	-	O	-	-
	Roof cable guide for PDC 50 and PDC 40 ELX H=4540 mm	8-43300028		-	-	-	-	O	O

ELECTRO-HYDRAULIC TWO POST LIFTS



PDCH 32 SERIES

ARMS WITH 2 SYMMETRICAL TELESCOPIC EXTENSIONS



Code	Electric Supply	Description
0-43102201/15	400V/ 3Ph/ 50-60Hz	PDCH 32 L floor level pipes.
0-43102211/15	230V/ 3Ph/ 50-60Hz	PDCH 32 L floor level pipes.
0-43102221/15	230V/ 1Ph/ 50Hz	PDCH 32 L floor level pipes.
8-43400001		Customization kit
0-43102202/15	400V/ 3Ph/ 50-60Hz	PDCH 32 LI sunken pipes.
0-43102212/15	230V/ 3Ph/ 50-60Hz	PDCH 32 LI sunken pipes.
0-43102222/15	230V/ 1Ph/ 50Hz	PDCH 32 LI sunken pipes.
8-43400002		Customization kit
0-43102203/15	400V/ 3Ph/ 50-60Hz	PDCH 32 V overhead pipes.
0-43102213/15	230V/ 3Ph/ 50-60Hz	PDCH 32 V overhead pipes.
0-43102223/15	230V/ 1Ph/ 50Hz	PDCH 32 V overhead pipes.
0-43102233/15	230V/ 1Ph/ 60Hz	PDCH 32 V overhead pipes.
8-43100170		Customization kit
0-43102204/15	400V/ 3Ph/ 50-60Hz	PDCH 32 CBP with NON load-bearing base
0-43102214/15	230V/ 3Ph/ 50-60Hz	PDCH 32 CBP with NON load-bearing base
0-43102224/15	230V/ 1Ph/ 50Hz	PDCH 32 CBP with NON load-bearing base
8-43400003		Customization kit

COMPULSORY ACCESSORIES - PDCH 32 SERIES

Image	Description	Code		PDCH 32 L	PDCH 32 LI	PDCH 32 V	PDCH 32 CBP
	<i>Anchor set.</i>	8-43100156		O	O	O	-
	<i>Anchor set.</i>	8-43100157		-	-	-	O

OPTIONAL ACCESSORIES - PDCH 32 SERIES

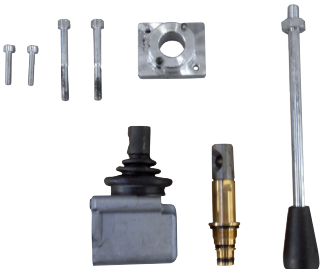
	<i>Pad extension set</i> (4 pcs.) H = mm 150.	8-43100153		O	O	O	O
	<i>Pad extension set</i> (4 pcs.) H = mm 200.	8-43100154		O	O	O	O
	<i>Manual emergency</i> descent pump.	8-411100103		O	O	O	O

PDCH 35C B

THREE-STAGE ASYMMETRICAL ARMS

Mainfeatures:

- Capacity: 4.500 kg.
- Single motor.
- Lifting system: with hydraulic cylinders and synchronisation with wire ropes on the column base.
- Three-stage asymmetric arms with pads adjustable in height and extensions supplied as standard.
- Minimum lifting height: 95 mm.
- Maximum lifting height: 1.945 mm

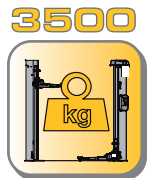

PN	Power supply	Description	
0-43107500/48	400V/3Ph/50-60Hz	PDCH 35C B - Grey RAL 7040 Orange peel - Capacity 3.500 kg.	
0-43107502/48	230V/1Ph/50Hz	PDCH 35C B - Grey RAL 7040 Orange peel - Capacity 3.500 kg.	
0-43107503/48	230V/1Ph/60Hz	PDCH 35C B - Grey RAL 7040 Orange peel - Capacity 3.500 kg.	
8-43400212		Customization kit for PDCH 35C B (Compulsory)	

Other colors than the standard are NOT currently provided

PDCH 45C B

THREE-STAGE ASYMMETRICAL ARMS

Mainfeatures:

- Capacity: 4.500 kg.
- Single motor.
- Lifting system: with hydraulic cylinders and synchronisation with wire ropes on the column
- Three-stage asymmetric arms with pads adjustable in height and extensions supplied as standard.
- Minimum lifting height: 95 mm.
- Maximum lifting height: 1.945 mm



4500







PN	Power supply	Description	
0-43107400/48	400V/3Ph/50-60Hz	PDCH 45C B - Grey RAL 7040 Orange peel - Capacity4.500 kg.	
0-43107402/48	230V/1Ph/50Hz	PDCH 45C B - Grey RAL 7040 Orange peel - Capacity4.500 kg.	
0-43107403/48	230V/1Ph/60Hz	PDCH 45C B - Grey RAL 7040 Orange peel - Capacity4.500 kg.	
8-43400214		Customization kit for PDCH 45C B (Compulsory)	

Other colors than the standard are NOT currently provided



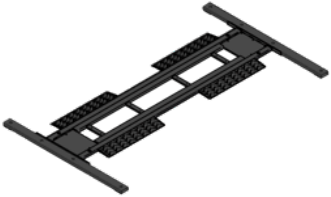



COMPULSORY ACCESSORIES FOR PDCH 45C B AND PDCH 35C B

Picture	Description	PN	
	Set tasselli di fissaggio (10 pz.). Per tutti i modelli della serie.	8-43100233	

OPTIONAL ACCESSORIES FOR PDCH 45C B AND PDCH 35C B

Picture	Description	PN	
	Main frame kit RAL7016. (To be order in case of location with critical floors).	8-43100222	
	Manual emergency descent pump.	8-43100205	
NEW! 	Multi-quick adapter	NX1316064	
NEW! 	Rubber pad for FIAT 500E	NX1316113	

OPTIONAL ACCESSORIES FOR PDCH 45C B AND PDCH 35C B

Picture	Description	PN	
	e-car KIT adapter 45° (1 set = 4 pieces)	8-43100275/00	
	Ø55mm Multi-adapter for Ø50mm pick-up , 1 piece	NX1316051	
	Ø55mm insert adapter with Ø29,5mm pin, for Multi-adapter NX1316051, 1 piece (Maserati)	NX1316052	
	Ø55mm insert adapter with 15mm slot, for Multi-adapter NX1316051, 1 piece (Rocker panel pick-up)	NX1316053	
	Ø55mm insert adapter with Ø20mm pin, for Multi-adapter NX1316051, 1 piece (Tesla)	NX1316054	
	Ø55mm insert adapter with beam shape 55x22,5x28 mm for Multi-adapter NX1316051, 1 piece (BMW & Mercedes EQ models)	NX1316055	
	Ø55mm insert adapter with half cylinder shape 55x26x13 mm for Multi-adapter NX1316051, 1 piece (Audi Q8 & Q8 e-tron)	NX1316056	

PDCH 40E SERIES

ARMS WITH 2 SYMMETRICAL
TELESCOPIC EXTENSIONS

4000

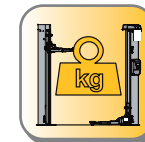

Code	Electric Supply	Description	
0-43401100/15	400V/ 3Ph/ 50-60Hz	PDCH 40E , portal H=3870.	
0-43401101/15	230V/ 3Ph/ 50-60Hz	PDCH 40E , portal H=3870.	
0-43401102/15	230V/ 1Ph/ 50Hz	PDCH 40E , portal H=3870.	
0-43105201/15	400V/ 3Ph/ 50-60Hz	PDCH 40E-V , portal H=4470.	
0-43105211/15	230V/ 3Ph/ 50-60Hz	PDCH 40E-V , portal H=4470.	
0-43105221/15	230V/ 1Ph/ 50Hz	PDCH 40E-V , portal H=4470.	
0-43401110/15	400V/ 3Ph/ 50-60Hz	PDCH 40E-XV , portal H=5070.	
0-43401111/15	230V/ 3Ph/ 50-60Hz	PDCH 40E-XV , portal H=5070.	
0-43401112/15	230V/ 1Ph/ 50Hz	PDCH 40E-XV , portal H=5070.	

PDCH 40N SERIES

ARMS WITH 3 SYMMETRICAL TELESCOPIC EXTENSIONS

4000



Code	Electric Supply	Description	
0-43401000/15	400V/ 3Ph/ 50-60Hz	PDCH 40N , arms with three symmetrical telescopic, portal H=3870.	
0-43401001/15	230V/ 3Ph/ 50-60Hz	PDCH 40N , arms with three symmetrical telescopic, portal H=3870.	
0-43401002/15	230V/ 1Ph/ 50Hz	PDCH 40N , arms with three symmetrical telescopic, portal H=3870.	
0-43105101/15	400V/ 3Ph/ 50-60Hz	PDCH 40N-V , arms with three symmetrical telescopic, portal H=4470.	
0-43105111/15	230V/ 3Ph/ 50-60Hz	PDCH 40N-V , arms with three symmetrical telescopic, portal H=4470.	
0-43105121/15	230V/ 1Ph/ 50Hz	PDCH 40N-V , arms with three symmetrical telescopic, portal H=4470.	
0-43401010/15	400V/ 3Ph/ 50-60Hz	PDCH 40N-XV , arms with three symmetrical telescopic, portal H=5070.	
0-43401011/15	230V/ 3Ph/ 50-60Hz	PDCH 40N-XV , arms with three symmetrical telescopic, portal H=5070.	
0-43401012/15	230V/ 1Ph/ 50Hz	PDCH 40N-XV , arms with three symmetrical telescopic, portal H=5070.	

PDCH 50 SERIES

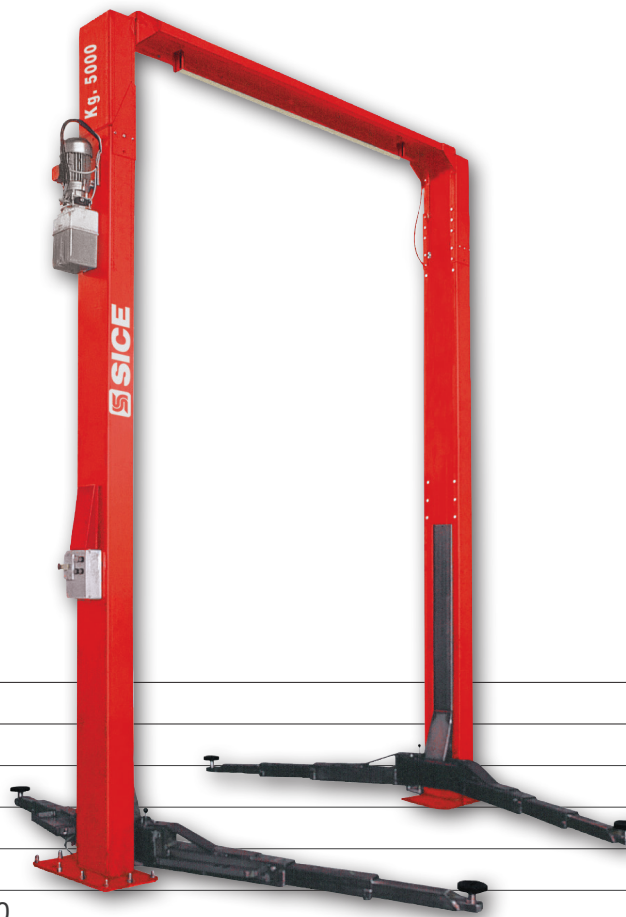
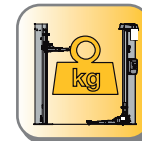

ARMS WITH 3 SYMMETRICAL
TELESCOPIC EXTENSIONS

5000





Code	Electric Supply	Description
0-43102401/15	400V/ 3Ph/ 50-60Hz	PDCH 50 , portal H=3870.
0-43102411/15	230V/ 3Ph/ 50-60Hz	PDCH 50 , portal H=3870.
0-43102421/15	230V/ 1Ph/ 50Hz	PDCH 50 , portal H=3870.
8-43400005		Customization kit
0-43102402/15	400V/ 3Ph/ 50-60Hz	PDCH 50 V , portal H=4470.
0-43102412/15	230V/ 3Ph/ 50-60Hz	PDCH 50 V , portal H=4470.
0-43102422/15	230V/ 1Ph/ 50Hz	PDCH 50 V , portal H=4470.
8-43400004		Customization kit
0-43102403/15	400V/ 3Ph/ 50-60Hz	PDCH 50 XV , portal H=5070.
0-43102413/15	230V/ 3Ph/ 50-60Hz	PDCH 50 XV , portal H=5070.
0-43102423/15	230V/ 1Ph/ 50Hz	PDCH 50 XV , portal H=5070.
8-43100172		Customization kit

COMPULSORY ACCESSORIES PDCH 40E-PDCH 40N-PDCH 50 SERIES

Image	Description	Code		PDCH 40E	PDCH 40E-V	PDCH 40E-XV	PDCH 40N	PDCH 40N-V	PDCH 40N-XV	PDCH 50	PDCH 50 V	PDCH 50 XV
	<p><i>Anchor set.</i></p>	<p>8-43100158</p>		O	O	O	O	O	O	-	-	-
	<p><i>Anchor set.</i></p>	<p>8-43100161</p>		-	-	-	-	-	-	O	O	O

OPTIONAL ACCESSORIES PDCH 40E-PDCH 40N-PDCH 50 SERIES

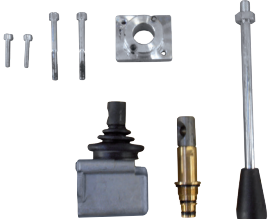
Image	Description	Code		PDCH 40E	PDCH 40E-V	PDCH 40E-XV	PDCH 40N	PDCH 40N-V	PDCH 40N-XV	PDCH 50	PDCH 50 V	PDCH 50 XV
	<p>Complete pad kit for FCA electric cars (1 pc) Ø 60mm, designed for FIAT 500 electric version</p>	8-43100229		○	○	○	○	○	○	○	○	○
	<p>Extensions for pads (4pcs) H=150 mm.</p>	8-43100159		○	○	○	○	○	○	-	-	-
	<p>Extensions for pads (4pcs) H=200 mm.</p>	8-43100160		○	○	○	○	○	○	-	-	-
	<p>Manual emergency descent pump.</p>	8-41100103		○	○	○	○	○	○	○	○	○

OPTIONAL ACCESSORIES PDCH 40E-PDCH 40N-PDCH 50 SERIES

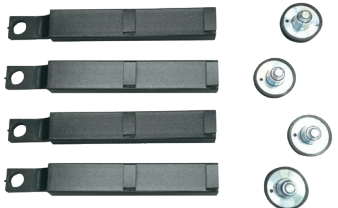
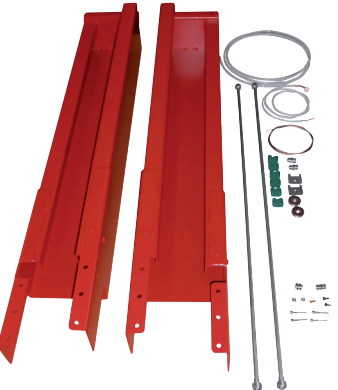
Image	Description	Code	PDCH 40E	PDCH 40E-V	PDCH 40E-XV	PDCH 40N	PDCH 40N-V	PDCH 40N-XV	PDCH 50	PDCH 50 V	PDCH 50 XV
	Set of extended height range pads (4pcs) H=80/170 mm.	8-43100192	-	-	-	O	O	O	-	-	-
IMMAGINE NON DISPONIBILE	Bar kit stopping ascent.	8-43100193	O	O	O	-	-	-	-	-	-
	Column extension set , H=600.	8-43700001/15	-	-	-	O	-	-	-	-	-
	Column extension set , H=1200.	8-43700002/15	-	-	-	O	O	-	-	-	-
	Column extension set , H=600.	8-43700003/15	O	-	-	-	-	-	-	-	-
	Column extension set , H=1200.	8-43700004/15	O	O	-	-	-	-	-	-	-
	Column extension set , H=600, to transform the hydraulic 2-post lift from H=4470 to H=5070 and from H=5070 to H=4470	8-43100197/00	-	-	-	-	-	-	-	O	O
	Column extension set , H=1200, to transform the hydraulic 2-post lift from H=3870 and H=4470 to H=5070	8-43100200/00	-	-	-	-	-	-	O	O	-

PDCH 55 XV SERIES

ARMS WITH 4 SYMMETRICAL
TELESCOPIC EXTENSIONS

5500



Code	Electric Supply	Description	
0-43404101/15	230-400V/ 3Ph/ 50-60Hz	PDCH 55 XV, capacity 5500 kg, symmetric arms	

COMPULSORY ACCESSORIES - PDCH 55 XV

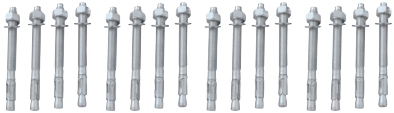
Image	Description	Code	
	<p><i>Fixing dowel set</i></p>	<p>8-43100161</p>	

OPTIONAL ACCESSORIES - PDCH 55XV

Image	Description	Code	
	<p><i>CRAFTER kit</i> (recommended)</p>	<p>8-43100183</p>	
	<p><i>Manual emergency</i> descent pump (recommended)</p>	<p>8-41100103</p>	

PDCH 40C

Main features:

-Capacity: 4.000 kg.

-Lift height: 3995 - 4220 mm

-Strong bended column with internal reinforcement,

2-part splitted to optimize transport and installation

-Asymmetric installation which grants a wider door opening angle.

-Encapsulated arm rotation locking system with 360-degree toothed engagement, ensuring stability and less maintenance.

-High performant pushing cylinders.

-CE safety stop

4000

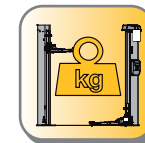



NEW!

PN	Power supply	Description	
0-43110200/1534	400V/3Ph/50-60Hz	PDCH 40C Hydraulic two post lift, top connection, lifting capacity 4.000 kg	
0-43110201/1534	230V/3Ph/50-60Hz	PDCH 40C Hydraulic two post lift, top connection, lifting capacity 4.000 kg	
0-43110202/1534	230V/1Ph/50Hz	PDCH 40C Hydraulic two post lift, top connection, lifting capacity 4.000 kg	
0-43110204/1534	230V/1Ph/60Hz	PDCH 40C Hydraulic two post lift, top connection, lifting capacity 4.000 kg	
8-43420044		Customization kit PDCH 40C Compulsory	









COMPULSORY ACCESSORIES FOR PDCH 40C

Picture	Description	PN	
NEW!	Set of 14 expansion bolts- 140mm	NX1316030	

OPTIONAL ACCESSORIES FOR PDCH 40C

Picture	Description	PN	
NEW!	Set of 2 base plate extensions	J213-4300000	
NEW!	Expansion bolts for base plate	NX1316014	
NEW!	Lifting pad single telescopic (78-110mm)	NX1316006	
NEW!	Lifting pad extension 50mm, 1 piece	NX1316010	
NEW!	Lifting pad extension 100mm, 1 piece	NX1316011	
NEW!	Lifting pad extension 150mm, 1 piece	NX1316016	
NEW!	Lifting pad extension 200mm, 1 piece	NX1316017	
NEW!	U-shape lifting pad adapter for standard lifting pad, 1 piece	NX1316004	
NEW!	Column extension 700mm	J213-4200000	
NEW!	Second lowering speed kit	J213-4100000	
NEW!	 Multi-quick adapter	NX1316064	
NEW!	 Rubber pad for FIAT 500E	NX1316113	

OPTIONAL ACCESSORIES FOR PDCH 40C

Picture	Description	PN	
	<p>Kit of 4 e-car adapters for ø50 mm pick-up</p>	8-48100075	
	<p>Ø55mm Multi-adapter for Ø50mm pick-up, 1 piece</p>	NX1316051	
	<p>Ø55mm insert adapter with Ø29,5mm pin, for Multi-adapter NX1316051, 1 piece (Maserati)</p>	NX1316052	
	<p>Ø55mm insert adapter with 15mm slot, for Multi-adapter NX1316051, 1 piece (Rocker panel pick-up)</p>	NX1316053	
	<p>Ø55mm insert adapter with Ø20mm pin, for Multi-adapter NX1316051, 1 piece (Tesla)</p>	NX1316054	
	<p>Ø55mm insert adapter with beam shape 55x22,5x28 mm for Multi-adapter NX1316051, 1 piece (BMW & Mercedes EQ models)</p>	NX1316055	
	<p>Ø55mm insert adapter with half cylinder shape 55x26x13 mm for Multi-adapter NX1316051, 1 piece (Audi Q8 & Q8 e-tron)</p>	NX1316056	
 <p>x4</p>	<p>Kit of 4 wheel support adapters, excentric pick-up, max. 1000 kg for each adapter for ø50mm pick-up hole</p>	8-48100073	

ELECTRO-HYDRAULIC TWO POST LIFTS

PDCH 45C

THREE-STAGE SYMMETRIC ARMS

Mainfeatures:

- Capacity: 4.500 kg.
- Possibility of installation in symmetrical or asymmetric version.
- Lifting system: with hydraulic cylinders and synchronisation with wire ropes on the column top.
- Standard height of two-post connection: 4,050 mm.
- Single motor.
- Electro magnet safety release 24V.
- Three-stage symmetric arms with pads adjustable in height and extensions supplied as standard.
- Anticrushing safety bar as standard.
- Minimum lifting height: 100 mm.
- Maximum lifting height: 2.080 mm.

Also available versions (with optional column extension set):

- V: High version specific for vans (Height of two-post connection: 4,620 mm).
- XV: Extra-above version specific for vans and very high vehicles (Height of two-post connection: 5.220 mm).



4500



PN	Power supply	Description	
0-43107800/15	400V/3Ph/50-60Hz	PDCH 45C - Red RAL 3002 Orange peel - Capacity 4.500 kg.	
0-43107802/15	230V/1Ph/50Hz	PDCH 45C - Red RAL 3002 Orange peel - Capacity 4.500 kg.	
0-43107803/15	230V/1Ph/60Hz	PDCH 45C - Red RAL 3002 Orange peel - Capacity 4.500 kg.	
8-43400217		Customization kit for PDCH 45C (Compulsory)	

ELECTRO-HYDRAULIC TWO POST LIFTS

PDCH 55C

THREE-STAGE SYMMETRIC ARMS

Mainfeatures:

- Capacity: 5.500 kg.
- Possibility of installation in symmetrical or asymmetric version.
- Lifting system: with hydraulic cylinders and synchronisation with wire ropes on the column top.
- Standard height of two-post connection: 4,050 mm.
- Single motor.
- Electro magnet safety release 24V.
- Three-stage symmetric arms with pads adjustable in height and extensions supplied as standard.
- Anticrushing safety bar as standard.
- Minimum lifting height: 100 mm.
- Maximum lifting height: 2.080 mm.

Also available versions (with optional column extension set):

- V: High version specific for vans (Height of two-post connection: 4,620 mm).
- XV: Extra-above version specific for vans and very high vehicles (Height of two-post connection: 5.220 mm).



5500







PN	Power supply	Description	
0-43107700/15	400V/3Ph/50-60Hz	PDCH 55C - Red RAL 3002 Orange peel - Capacity 5.500 kg.	
0-43107702/15	230V/1Ph/50Hz	PDCH 55C - Red RAL 3002 Orange peel - Capacity 5.500 kg.	
0-43107703/15	230V/1Ph/60Hz	PDCH 55C - Red RAL 3002 Orange peel - Capacity 5.500 kg.	
8-43400216		Customization kit for PDCH 55C (Compulsory)	





COMPULSORY ACCESSORIES FOR PDCH 55C - PDCH 45C

Picture	Description	PN	
	Set of masonry screws (16 pcs.). For all models in the range.	8-43100161	

OPTIONAL ACCESSORIES FOR PDCH 55C - PDCH 45C

Picture	Description	PN	
	Column extension set L=600 mm	8-43100224/15	
	Column extension set L=1.200 mm	8-43100225/15	
	Manual emergency descent pump.	8-43100205	
NEW! 	Multi-quick adapter	NX1316064	
NEW! 	Rubber pad for FIAT 500E	NX1316113	

OPTIONAL ACCESSORIES FOR PDCH 55C - PDCH 45C

Picture	Description	PN	
	<p>e-car KIT adapter 45° (1 set = 4 pieces)</p>	8-43100275/00	
	<p>Ø55mm Multi-adapter for Ø50mm pick-up, 1 piece</p>	NX1316051	
	<p>Ø55mm insert adapter with Ø29,5mm pin, for Multi-adapter NX1316051, 1 piece (Maserati)</p>	NX1316052	
	<p>Ø55mm insert adapter with 15mm slot, for Multi-adapter NX1316051, 1 piece (Rocker panel pick-up)</p>	NX1316053	
	<p>Ø55mm insert adapter with Ø20mm pin, for Multi-adapter NX1316051, 1 piece (Tesla)</p>	NX1316054	
	<p>Ø55mm insert adapter with beam shape 55x22,5x28 mm for Multi-adapter NX1316051, 1 piece (BMW & Mercedes EQ models)</p>	NX1316055	
	<p>Ø55mm insert adapter with half cylinder shape 55x26x13 mm for Multi-adapter NX1316051, 1 piece (Audi Q8 & Q8 e-tron)</p>	NX1316056	

PQC 40 SERIES

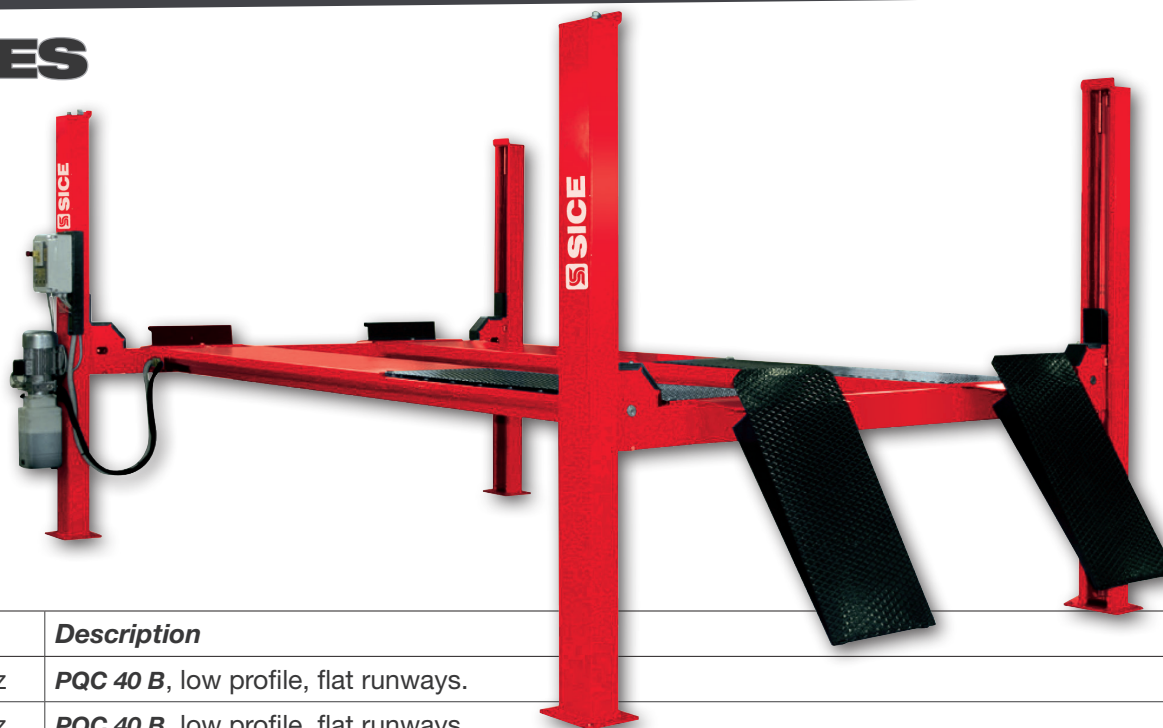

4000

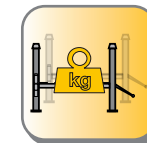

Code	Electric Supply	Description	
0-43102501/15	400V/ 3Ph/ 50-60Hz	PQC 40 B , low profile, flat runways.	
0-43102511/15	230V/ 3Ph/ 50-60Hz	PQC 40 B , low profile, flat runways.	
0-43102521/15	230V/ 1Ph/ 50Hz	PQC 40 B , low profile, flat runways.	
8-43100173		Customization kit	
0-43102502/15	400V/ 3Ph/ 50-60Hz	PQC 40 B CT , low profile, recessed runways for wheel alignment.	
0-43102512/15	230V/ 3Ph/ 50-60Hz	PQC 40 B CT , low profile, recessed runways for wheel alignment.	
0-43102522/15	230V/ 1Ph/ 50Hz	PQC 40 B CT , low profile, recessed runways for wheel alignment.	
8-43100174		Customization kit	
0-43103701/15	400V/ 3Ph/ 50-60Hz	PQC 40 W CT , wheel alignment runways.	
0-43103711/15	230V/ 3Ph/ 50-60Hz	PQC 40 W CT , wheel alignment runways.	
0-43103721/15	230V/ 1Ph/ 50Hz	PQC 40 W CT , wheel alignment runways.	
8-43100175		Customization kit	

PQC 50 SERIES

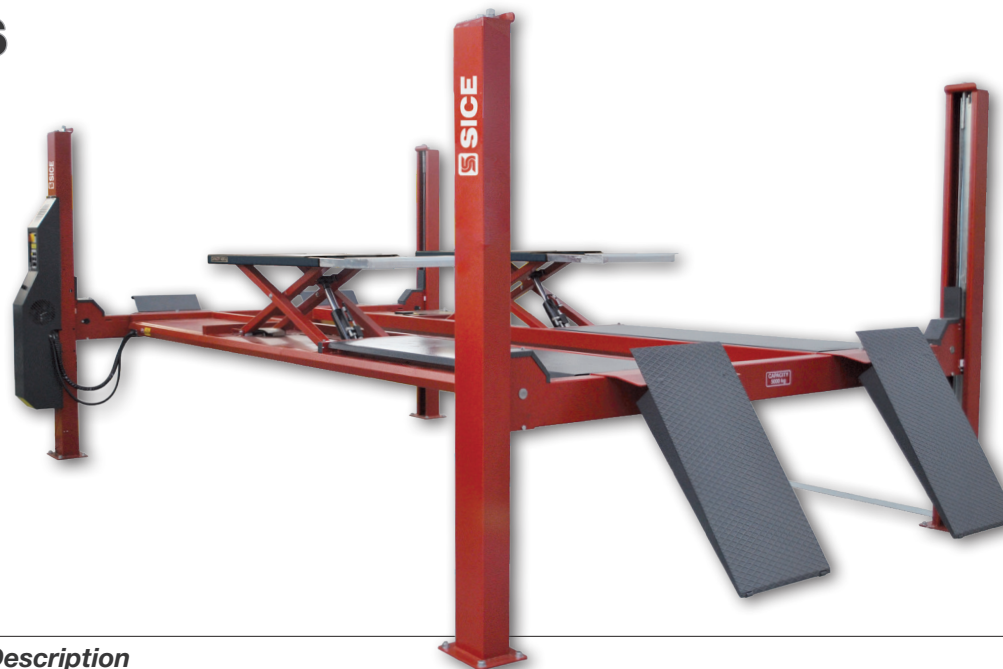

5000

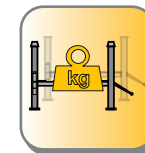



Code	Electric Supply	Description	
0-43103801/15	400V/ 3Ph/ 50-60Hz	PQC 50 W , recessed runways for wheel alignment.	
0-43103811/15	230V/ 3Ph/ 50-60Hz	PQC 50 W , recessed runways for wheel alignment.	
0-43103821/15	230V/ 1Ph/ 50Hz	PQC 50 W , recessed runways for wheel alignment.	
8-43400006		Customization kit	
0-43103802/15	400V/ 3Ph/ 50-60Hz	PQC 50 W CT , wheel alignment runways.	
0-43103812/15	230V/ 3Ph/ 50-60Hz	PQC 50 W CT , wheel alignment runways.	
0-43103822/15	230V/ 1Ph/ 50Hz	PQC 50 W CT , wheel alignment runways.	
8-43100176		Customization kit	
0-43409701/15	400V/ 3Ph/ 50-60Hz	PQC 50 CT LT EVO , wheel alignment runways, Lift Table.	
0-43409711/15	230V/ 3Ph/ 50-60Hz	PQC 50 CT LT EVO , wheel alignment runways, Lift Table.	
0-43409721/15	230V/ 1Ph/ 50Hz	PQC 50 CT LT EVO , wheel alignment runways, Lift Table.	



COMPULSORY ACCESSORIES PQC 40 - PQC 50 SERIES

Image	Description	Code		PQC 40B	PQC 40B CT	PQC 40 W CT	PQC 50 W	PQC 50 W CT	PQC 50 CT LT
	Anchor set.	8-43100162		O	O	O	O	O	O

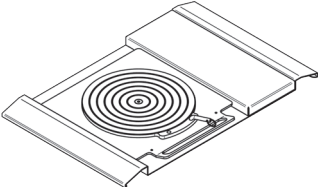
OPTIONAL ACCESSORIES PQC 40 - PQC 50 SERIES

Image	Description	Code		PQC 40B	PQC 40B CT	PQC 40 W CT	PQC 50 W	PQC 50 W CT	PQC 50 CT LT
	Manual emergency descent pump.	8-41100103		O	O	O	O	O	O
	Turntables set.	8-43100163		-	-	-	O	-	-
	Turntables set H=31 mm	8-43100166		-	O	-	-	-	-

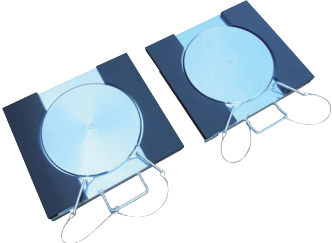
OPTIONAL ACCESSORIES PQC 40 - PQC 50 SERIES

OPTIONAL ACCESSORIES PQC 40 - PQC 50 SERIES				PQC 40B	PQC 40B CT	PQC 40 W CT	PQC 50 W	PQC 50 W CT	PQC 50 CT LT
Image	Description	Code							
	Pair of car mechanical turntables with ROC Push-mode kit (400x450x50H mm).	8-33100102		-	-	0	-	0	0
IMAGE NOT AVAILABLE	Ramps kit (2 pcs) for « drive-through » installation, length = 900mm	8-43100249		-	-	0	0	0	-
	JB 20 - pneumo-hydraulic scissor lift cross-bar.	8-42100120		0	0	0	0	0	0
	Customization kit for JB 20.	8-43100181		0	0	0	0	0	0
IMAGE NOT AVAILABLE	Short flaps for drive-over, for recessed 4-post lift, 1 set = 2 pcs	8-43100219		-	-	0	0	0	-

S 227

2500

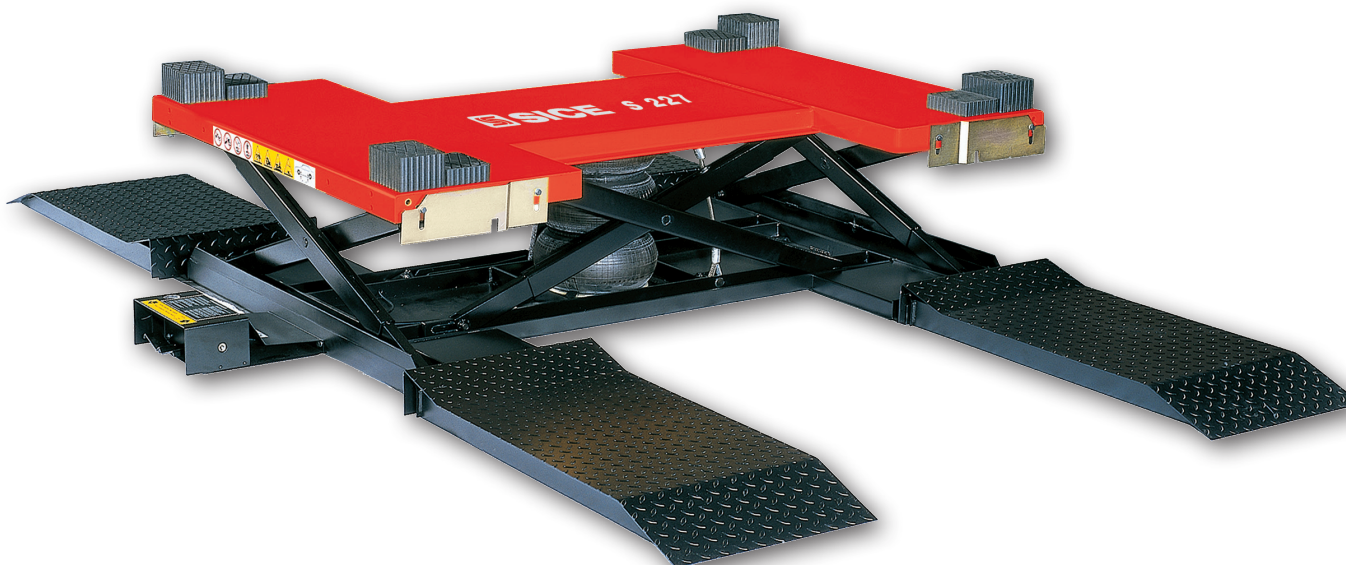

Code	Description	
0-44100901/15	S 227 pneumatic platform lift.	

OPTIONAL ACCESSORIES S 227

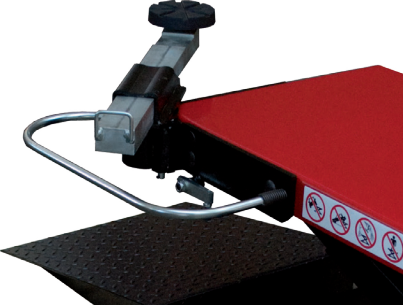
<i>Image</i>	<i>Description</i>	<i>Code</i>	
	<p><i>Set of 4</i> telescopic arms.</p>	8-42600015	

MOTORCYCLE LIFTS

PM 26

MANUAL WHEEL FIXING
SICKLE CLAMP INCLUDED

600



PM 23

MANUAL WHEEL FIXING
SICKLE CLAMP INCLUDED

300





Code	Electric Supply	Description	
0-42107200/16	400V/3Ph/50-60Hz	PM 26	
0-42107201/16	230V/1Ph/50-60Hz	PM 26	

Code	Electric Supply	Description	
0-42107100/16	AIR HYDRAULIC	PM 23	

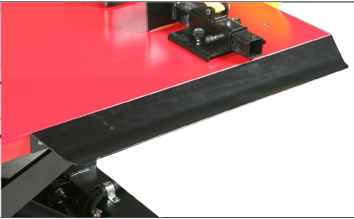

OPTIONAL ACCESSORIES PM 26 - PM 23

Image	Description	Code		PM 26	PM 23
	<p>PC Pneumatic manual fixing sickle clamp.</p>	<p>8-42600001</p>		<p>O</p>	<p>O</p>
	<p>ML Manual wheel fixing sickle clamp.</p>	<p>8-42600002</p>		<p>O</p>	<p>O</p>
	<p>Pneumatic wheel fixing sickle clamp, pedal operated.</p>	<p>8-42600006</p>		<p>O</p>	<p>O</p>
	<p>Wearproof top.</p>	<p>8-42600010</p>		<p>O</p>	<p>O</p>
	<p>Spent oil recovery tank.</p>	<p>8-42600011</p>		<p>-</p>	<p>O</p>

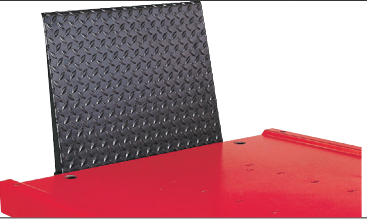
OPTIONAL ACCESSORIES PM 26 - PM 23

Image	Description	Code		PM 26	PM 23
IMAGE NOT AVAILABLE	Spent oil <i>recovery tank</i> .	8-42300006		O	-
	<i>Tools holder</i> .	8-42600012		O	O
	<i>Support</i> for side stand.	8-42300002		O	O
	<i>Fixing belts</i> (pair).	8-42300003		O	O
	<i>Drive-through kit</i> .	8-42300004		O	-
IMAGE NOT AVAILABLE	<i>In-pit installation kit</i> .	8-41600017		O	-

OPTIONAL ACCESSORIES PM 26 - PM 23

Image	Description	Code		PM 26	PM 23
	<p>Set of 4 runways side extensions.</p>	<p>8-42300008</p>		<p>O</p>	<p>-</p>
	<p>CM300 Stand kit. 300 kg capacity.</p>	<p>8-45600001</p>		<p>O</p>	<p>O</p>
	<p>Stand kit for CM 300 (4 pcs: 2 long and 2 short).</p>	<p>8-45600005</p>		<p>O</p>	<p>O</p>

K002



K118



K240



K240P



K330



K440



Code	Description	
0-43302002/16	K002 CE lifting capacity 2000 kg.	
0-43302118/16	K118 lifting capacity 16000 kg.	
0-43302240/16	K240 lifting capacity 28000 kg.	
0-43302241/16	K240P lifting capacity 28000 kg. (economic lever)	
0-43302330/16	K330 lifting capacity 60000 kg.	
0-43302440/16	K440 lifting capacity 40000 kg.	

PMC65 H / PMC75 H / PMC86 H SERIES

NEW!



6500
7500
8600



BATTERIES 24V DC
MAX. 8 COLUMNS CAN BE CONNECTED
HYDRAULIC OIL NOT INCLUDED - RECOMMENDED OIL:
ISOAW46, 15 LITERS

Code	Description	
0-43108700/64	PMC65 H WIRELESS HYDRAULIC MOBILE COLUMN 6.5 TON WITH ADJUSTABLE FORKS	
8-43420038	Customization kit for SICE PMC65H compulsory	
0-43108800/64	PMC75 H WIRELESS HYDRAULIC MOBILE COLUMN 7.5 TON WITH ADJUSTABLE FORKS	
8-43420039	Customization kit for SICE PMC75H compulsory	
0-43108900/64	PMC86 H WIRELESS HYDRAULIC MOBILE COLUMN 8.6 TON WITH ADJUSTABLE FORKS	
8-43420040	Customization kit for SICE PMC86 H compulsory	

OPTIONAL ACCESSORIES FOR WIRELESS HYDRAULIC MOBILE COLUMNS

Image	Code	Description	
	NX155023001010	<i>Jack stand</i> 12 ton	
	NX155023001040	<i>Frame lifting beam</i>	
	NX155023001077	<i>Beam kit</i> with trailer adapter	
	NX155023001098	<i>Additional cable kit</i> (cable + support)	
	NX155023001099	<i>Additional cable kit</i> (plug socket + cable+ support)	
	NX155023001072	<i>Beam kit</i> for pick up (only 8600 kg)	

LIFTS FOR TRUCKS AND INDUSTRIAL VEHICLES WITH MOBILE COLUMNS

MC 75



7500



POWER CABLE NOT INCLUDED

Code	Electrical Supply	Description	
0-43401200/15	400V/ 3Ph/ 50Hz	MC 75-4 Set of 4 electromechanical mobile columns, 7.5 tons	
0-43401202/15	230V/ 3Ph/ 60Hz	MC 75-4 Set of 4 electromechanical mobile columns, 7.5 tons	
0-43401210/15	400V/ 3Ph/ 50Hz	MC 75-2 Set of 2 electromechanical mobile columns, 7.5 tons (in addition to MC 75-4)	
0-43401212/15	230V/ 3Ph/ 60Hz	MC 75-2 Set of 2 electromechanical mobile columns, 7.5 tons (in addition to MC 75-4)	
0-43401230/15	400V/ 3Ph/ 50Hz	MC 75-4 Set of 4 electromechanical mobile columns, 7.5 tons, with adjustable forks	
0-43401232/15	230V/ 3Ph/ 60Hz	MC 75-4 Set of 4 electromechanical mobile columns, 7.5 tons, with adjustable forks	
0-43401240/15	400V/ 3Ph/ 50Hz	MC 75-2 Set of 2 electromechanical mobile columns, 7.5 tons (in addition to MC 75-4) with adjustable forks	
0-43401242/15	230V/ 3Ph/ 60Hz	MC 75-2 Set of 2 electromechanical mobile columns, 7.5 tons (in addition to MC 75-4) with adjustable forks	

MC 55



WITH HELM
HYDRAULIC
CONTROL



5500







VERSION WITH
ADJUSTABLE FORKS

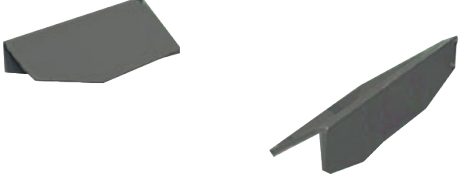
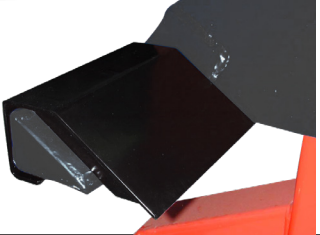

POWER CABLE NOT INCLUDED

Code	Electrical Supply	Description	
0-43401300/15	400V/ 3Ph/ 50Hz	MC 55-4 Set of 4 electromechanical mobile columns, 5.5 tons.	
0-43401302/15	230V/ 3Ph/ 60Hz	MC 55-4 Set of 4 electromechanical mobile columns, 5.5 tons.	
0-43401310/15	400V/ 3Ph/ 50Hz	MC 55-2 Set of 2 electromechanical mobile columns, 5.5 tons (in addition to MC 55-4).	
0-43401312/15	230V/ 3Ph/ 60Hz	MC 55-2 Set of 2 electromechanical mobile columns, 5.5 tons (in addition to MC 55-4).	
0-43401330/15	400V/ 3Ph/ 50Hz	MC 55-4 Set of 4 electromechanical mobile columns, 5.5 tons, with adjustable forks.	
0-43401332/15	230V/ 3Ph/ 60Hz	MC 55-4 Set of 4 electromechanical mobile columns, 5.5 tons, with adjustable forks.	
0-43401340/15	400V/ 3Ph/ 50Hz	MC 55-2 Set of 2 electromechanical mobile columns, 5.5 tons (in addition to MC 55-4) with adjustable forks.	
0-43401342/15	230V/ 3Ph/ 60Hz	MC 55-2 Set of 2 electromechanical mobile columns, 5.5 tons (in addition to MC 55-4) with adjustable forks.	

OPTIONAL ACCESSORIES - MC 75 - MC 55

Image	Description	Code	
	Complete <i>remote control unit</i>	8-43100208	
	Complete <i>cart</i>	8-43100210/00	
	<i>Extensions</i> for forks 150mm (2cs); for one column.	8-43120008	
	<i>Adapters kit</i> for wheels Ø 700 to 500mm (2 pcs); for one column.	8-43120009	
	<i>Adapters kit</i> for wheels Ø 800 to 700mm (2 pcs); for one column.	8-43120010	
	<i>Adapters kit</i> for wheels Ø 900 to 800mm (2 pcs); for one column.	8-43120011	
	<i>Free crossbar wheels</i> , 15 tons.	8-43120012	

OPTIONAL ACCESSORIES - MC 75 - MC 55

Image	Description	Code	
	<p>Warning light, for one column.</p>	8-43120013	
	<p>One small column H 1403/2000 mm, with 70mmscrew, 7.5 tons.</p>	8-43120014	
	<p>One small column H 1403/2000 mm, with 70mmscrew, 10 tons.</p>	8-43120015	
	<p>10 mt-cable + connection kit for 6 to 8 columns.</p>	8-43120016	
<p>IMAGE NOT AVAILABLE</p>	<p>Ramps kit (2 pcs) for « drive-through » installation, length = 900mm</p>	8-43100249	

PSRC 280 SERIES



STANDARD EQUIPMENT ON FLOOR

- 1 hose covering,
- 4 Flex hoses L=8000,
- ONE WAY VERSION 2 ramps + 4 movable boards,
- DRIVE-THROUGH VERSION 4 ramps + 4 movable boards.

STANDARD EQUIPMENT FLUSH MOUNTED VERSION

- 4 flex hoses L8000,
- 4 movable boards.

OPTIONAL ACCESSORIES

- Lifting beams,
- Light kit,
- Automatic pit-covering platforms,
- Alignment kit,
- Air kit
- Anchor bolts kit.

NEW!

**HYDRAULIC OIL NOT INCLUDED - RECOMMENDED OIL:
ISOAW46, 60 LITERS**



18000 KG
according to EN1493
UP TO 28000 KG
with symmetrical loading

Code	Electrical Supply	Description	
0-43110600/6464	400V/3PH/50Hz	PSRC 280/80 L8000 ONE WAY	
8-42420056		Customization kit PSRC 280/80 compulsory	
0-43110610/6464	400V/3PH/50Hz	PSRC 280/80 L8000 DRIVE-THROUGH	
8-42420056		Customization kit PSRC 280/80 compulsory	
0-43110650/6464	400V/3PH/50Hz	PSRC 280/80 L8000 FLUSH MOUNTED DRIVE-THROUGH	
8-42420056		Customization kit PSRC 280/80 compulsory	

Code	Electrical Supply	Description	
0-43110700/6464	400V/3PH/50Hz	PSRC 280/90 L9000 ONE WAY	
8-42420057		Customization kit PSRC 280/90 compulsory	
0-43110710/6464	400V/3PH/50Hz	PSRC 280/90 L9000 DRIVE-THROUGH	
8-42420057		Customization kit PSRC 280/90 compulsory	
0-43110750/6464	400V/3PH/50Hz	PSRC 280/90 L9000 FLUSH MOUNTED DRIVE-THROUGH	
8-42420057		Customization kit PSRC 280/90 compulsory	
0-43110800/6464	400V/3PH/50Hz	PSRC 280/100 L10000 ONE WAY	
8-42420058		Customization kit PSRC 280/100 compulsory	
0-43110810/6464	400V/3PH/50Hz	PSRC 280/100 L10000 DRIVE-THROUGH	
8-42420058		Customization kit PSRC 280/100 compulsory	
0-43110850/6464	400V/3PH/50Hz	PSRC 280/100 L10000 FLUSH MOUNTED DRIVE-THROUGH	
8-42420058		Customization kit PSRC 280/100 compulsory	
0-43110900/6464	400V/3PH/50Hz	PSRC 280/110 L11000 ONE WAY	
8-42420059		Customization kit PSRC 280/110 compulsory	
0-43110910/6464	400V/3PH/50Hz	PSRC 280/110 L11000 DRIVE-THROUGH	
8-42420059		Customization kit PSRC 280/110 compulsory	
0-43110950/6464	400V/3PH/50Hz	PSRC 280/110 L11000 FLUSH MOUNTED DRIVE-THROUGH	
8-42420059		Customization kit PSRC 280/110 compulsory	
0-43111000/6464	400V/3PH/50Hz	PSRC 280/118 L11800 ONE WAY	
8-42420060		Customization kit PSRC 280/118 compulsory	
0-43111010/6464	400V/3PH/50Hz	PSRC 280/118 L11800 DRIVE-THROUGH	
8-42420060		Customization kit PSRC 280/118 compulsory	
0-43111050/6464	400V/3PH/50Hz	PSRC 280/118 L11800 FLUSH MOUNTED DRIVE-THROUGH	
8-42420060		Customization kit PSRC 280/118 compulsory	

